

Delivering Reliability Under Pressure

BULLETIN VAC  
Revised Feb. 2023

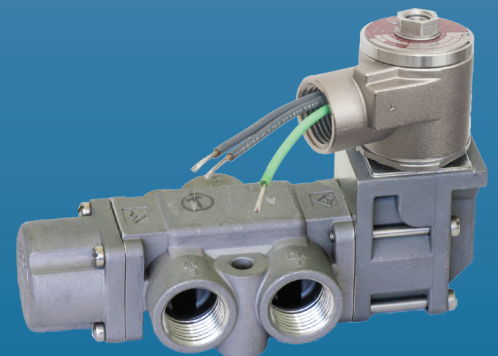

SOLENOID VALVES & ACCESSORIES FOR VALVE AUTOMATION

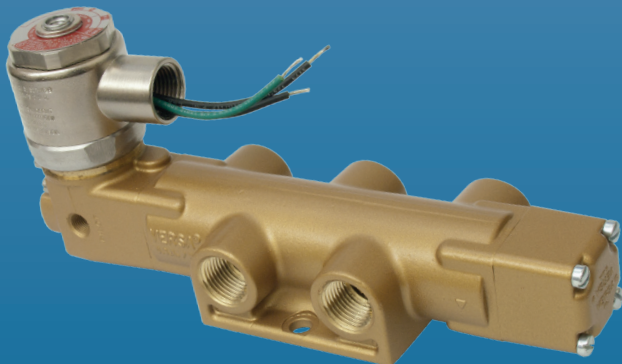
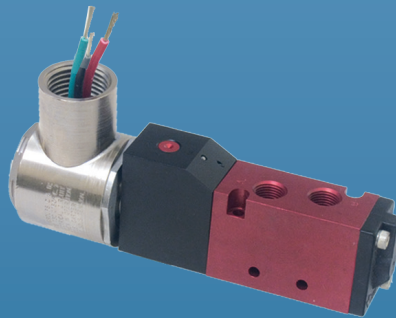
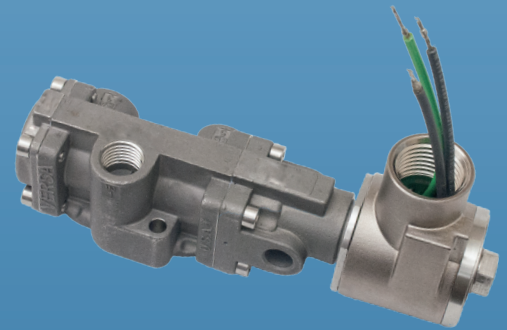

Versa Products Company, Inc., 22 Spring Valley Road, Paramus, New Jersey 07652 TEL: (201) 843-2400 Fax: (201) 843-2931  
Versa BV., Prins Willem Alexanderlaan 1427, 7312 GB Apeldoorn, The Netherlands TEL: +31-55-3681900 FAX: +31-55-3681909

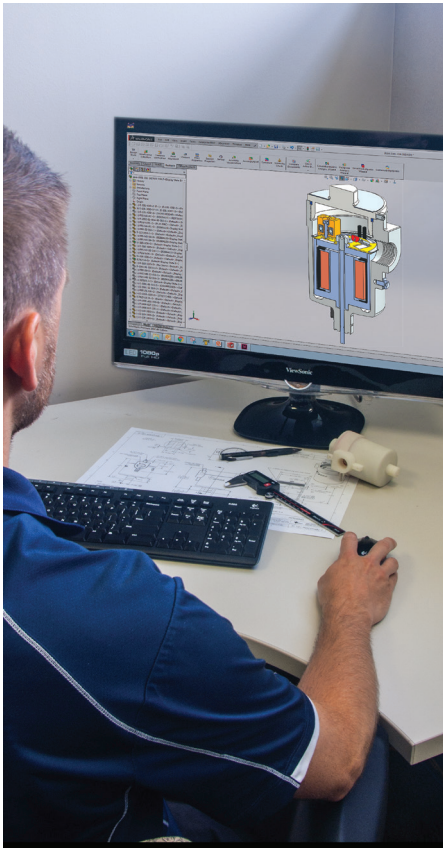

## QUALITY IS ABSOLUTE

Quality has no degrees at Versa. There is no such thing as “pretty good” or “almost right”. Every product is designed and manufactured to conform to uniformly high standards.

These standards are assured by a quality management system which includes ISO 9001 certification and testing of all products prior to shipment.



## THE COMMITMENT CONTINUES

Fluid Power is our business. It is our only business, so we have to be good at it. Since its beginning in 1949, Versa has maintained its commitment to quality products and satisfied customers.

Versa has succeeded in serving industry’s needs with a broad line of directional control devices. Our focus on product variety, technical expertise and company support remains constant. It all begins with a responsiveness to industry needs and ends with delivery of the valve or system you need—when you need it.

We view ourselves as problem solvers and that role requires more than making good products. It is what we do before and after that is equally important. From drawing board to user satisfaction, our commitment is continuous.

No matter how tough the application or environmental demands, Versa offers you a choice of valves to meet the challenge. Advanced design, durable construction materials and rigid manufacturing standards provide valves you can rely on for years of trouble-free performance.

Be it a single valve or a pneumatic system, Versa’s commitment to quality is uncompromising.

## HOW WE PUT IT TOGETHER IS WHAT SETS US APART

Versa is not the biggest manufacturer of directional control valves, so we try to be the best.

Design, manufacture, quality control, pricing, delivery - whatever the function - it must be geared to customer needs.

Many companies sell valves. At Versa we sell satisfaction.

## WORLDWIDE ACCESSIBILITY

More than 1000 fluid power representatives and over 100 stocking locations comprise Versa’s worldwide distribution system. They are supported by manufacturing and technical centers in the United States and The Netherlands.

The distributor network is the key to customer service and the source of continuous application feedback. Versa uses this input as part of its research and development program in an effort to respond to individual and industry needs.

Versa makes certain that our distributors’ sales and service personnel receive factory training on an ongoing basis. This includes basic theory, product indoctrination and seminars.

Our distributor family is a source of pride to Versa—but more important—it is a source of support and service to all of our customers.

Contact Versa for the distributor servicing your specific area.

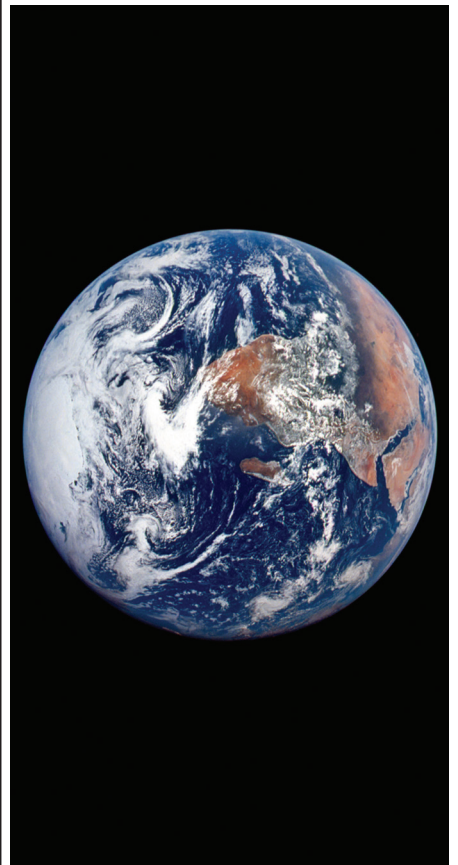



Versa exercises diligence to assure that information contained in this catalog is correct, but does not accept responsibility for any errors or omissions. Versa also reserves the right to change or delete data or products at any time without prior notification. To be sure the data you require is correct, consult factory.

# CONTENTS GUIDE

## Direct Mount Actuator Valves

<b>NAMUR (Series C5) 4-Way</b> .....	Page 4 - 7
<b>NAMUR (Series E5) 3-Way</b> .....	Page 4 - 6
<b>NAMUR (Series C-316) 3-Way &amp; 4 way</b> .....	Page 4 - 7

## Body Ported Valves

<b>Stainless Steel (Series E &amp; E5) 3-Way</b> .....	Page 8 - 9
<b>Stainless Steel (Series D316) 3-Way</b> .....	Page 10 - 11
<b>Aluminum (Series C5 &amp; C7) 3-Way &amp; 4 way</b> .....	Page 12 - 13
<b>Brass (Series V) 3-Way &amp; 4 way</b> .....	Page 14 - 15
<b>Stainless Steel (Series C-316) 3-Way &amp; 4 way</b> .....	Page 16 - 17
<b>Stainless Steel (Series V-316) 3-Way &amp; 4 way</b> .....	Page 18 - 19

## Special Purpose Dual Solenoid Valves

<b>Brass (Series V) or Stainless Steel (Series V-316)</b> 3-Way & 4-Way .....	Page 20 - 21
--	--------------

## Latching/Manual Reset Valves:

<b>Brass (Series V) or Stainless Steel (Series V-316)</b> 3-Way & 4-Way .....	Page 22 - 23
--	--------------

## Lockout Valves:

<b>Brass (Series V) or Stainless Steel (Series V-316)</b> 3-Way & 4-Way .....	Page 24
--	---------

## Modular Air Packages CMAP - VMAP

<b>Stainless Steel (Series C-316 &amp; Series V-316)</b> VMAP .....	Page 30
--	---------

## Air Preparation

<b>Stainless Steel (Filters/Regulators)</b> Filters and Regulators .....	Page 31 - 33
---	--------------

## Accessories

<b>Stainless Steel (Dust Excluders, Vent Screens, Bleed Controls, Relief Valve &amp; Quick Exhaust )</b> <b>Aluminum (Dust Excluders)</b> <b>Brass (Bleed Controls &amp; Shuttle Valves)</b> Accessories .....	Page 33 - 35
---	--------------

## Technical Information:

Hazardous Location Combination Suffix Details .....	Page 25
Non-Hazardous Service Solenoids .....	Page 26 -28
Hazardous Service Solenoids .....	Page 26 -29
Miscellaneous Options .....	Page 29

<b>Warranty</b> .....	Page 32
-----------------------	---------

# DIRECT MOUNT ACTUATOR VALVES

ALUMINUM

STAINLESS STEEL

## GENERAL DESCRIPTION

The Versa NAMUR mount control valves are high flow, bubbletight, direct acting or solenoid/pilot operated. They are designed to mount directly to any NAMUR actuator, thus reducing actuator response time and cost of tubing, fittings, brackets, and labor. These valves are available in two materials - Aluminum and 316L stainless steel.

E5 is a direct acting 3-way (3/2) solenoid valve. C5, C9 and C316 are solenoid/pilot operated high flow, 5-port NAMUR valves. They are available as single or double solenoid 2-position (C5 - C316) and 3-position (C5) models. Single solenoid spring return models utilize an air assisted spring return feature, assuring a positive return. Double solenoid valves may be used in applications where a momentary signal is required or in a "fail in last shifted position" actuator application.

A complete selection of electrical connections, area classifications, and power requirements makes the most exacting and demanding specifications or applications easy to satisfy.

**E5 NAMUR**



### General Description

The aluminum E5 NAMUR mount control valve is an inexpensive, simple and effective 3-way direct-acting solenoid valve. It is designed to mount directly to any actuator with NAMUR footprint thus reducing cost of tubing, fittings, brackets and labor.

It is most effective on spring return or fail-safe actuators where high speed open or close is not important, but where cost is a factor. A threaded actuator vent port is standard.

Available as a 3-way, 2-position, direct acting solenoid, spring return only, and with most of the Versa solenoid options.

**C5 C9 NAMUR**



### General Description

The aluminum 1/4" C5 & 1/2" C9 NAMUR are available as either 4-way (for double acting actuators) or 3-way (for spring return or fail-safe actuators). This valve is field convertible utilizing no special tools, gaskets, or sealants.

Relocation of a port plug on the C5 and a sandwich plate on the C9 converts a 3-way to a 4-way, or a 4-way to a 3-way. When the 4-way valve is converted to 3-way function, the unused exhaust port becomes an actuator vent into which a filter/muffler can be installed to prevent contaminants from entering either the valve or the actuator. Also see ReBreather page 7.

Single solenoid models (for 2-position control), or double solenoid models (for 2 or 3-position control) are available. Actuator positioning is possible with the use of 3-position valves since all Versa C-series NAMUR valves are bubbletight.

**C316 NAMUR**

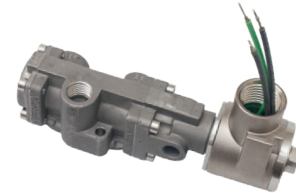

### General Description

The stainless steel C316 NAMUR valve is available as either a 4-way (for double acting actuators) or as a 3-way (for spring return actuators).

When the 3-way function is utilized, the unused exhaust port becomes an actuator vent where a filter/muffler can be installed to prevent contaminants from entering the valve or the actuator.

The 5-port design allows the user to independently control actuator speed in either open or closed direction by utilizing speed or bleed controls.

Double solenoid models are equipped with a detent that maintains the valve in the last shifted position, even in high vibration applications.

## SPECIFICATIONS

### Materials

Valve Body:	E5, C5 & C9 C316,	Anodized aluminum 316L Stainless Steel
Plunger:	C5, C9 C316, E5	Anodized aluminum Stainless Steel (C316: 316L)
Actuating Caps:	C5, C9 C316	Solenoid – anodized aluminum. Spring cap – synthetic resin. Solenoid and spring cap – 316L Stainless Steel
Pilot Piston:	C5, C9 C316	Synthetic resin 316L Stainless Steel
Valve Seals:	C5, C9, C316, E5: E5, C5, C9 C316	Plunger and body – FKM (fluorocarbon) Mounting O rings valve/actuator – NBR (nitrile) Mounting O rings valve/actuator – FKM (fluorocarbon)
Body Screws:	C5, C9, & C316	Stainless steel
Solenoid Parts:	E5, C5, C9 & C316	Sleeve, plunger & spring stainless steel Coils – epoxy molded with 3 spade terminals (std). Coil housing (per coil option selected) see page 26-29

### PortSize

Inlet and exhaust	E5, C5	1/4 NPT, (G1/4 available)
	C316	1/4 NPT
	C9	1/2 NPT

### Flow Rates

		Cv (average for all ports)
Inlet and exhaust	E5	0.08
	C5	0.75
	C9	3.5
	C316	1.6

### Installation and Filtration

Valves:	No limitations on mounting orientation.
Filtration:	40 to 50 micron

### Options

See Options pages 6 & 29



# DIRECT MOUNT ACTUATOR VALVES

## SPECIFICATIONS

Valve Type	Operating Pressure Range* Pneumatic			
	E5	C5	C9	C316
Single Solenoid/Spring Return (2-position)	0-150 psi (0-10.3 bar)	15-115 psi (1-8 bar)	30-150 (2-10.3 bar)	25-150 psi (1.8-10.3 bar)
Double Solenoid/Detented (2-position)	—	10-115 psi (0.7-8 bar)	20-150 psi (1-10.3 bar)	15-150 psi (1-10.3 bar)
Double Solenoid/Spring Centered (3-position)	—	15-115 psi (1-8 bar)	30-150 (2-10.3 bar)	—

\* Pressures ranges may change based on solenoid option. See page 27. For applications above 125 psi (8.6 bar) exhaust flow controls or mufflers are recommended.

## VALVE PRODUCT NUMBER SELECTOR

C5, C9, C-316, E5 & NAMUR				Basic Valve Number*			
SERIES	FUNCTION**	PORT SIZE	Cv	SINGLE SOLENOID/SPRING RETURN, 2 POSITION	DOUBLE SOLENOID/DETENT, 2 POSITION	DOUBLE SOLENOID/SPRING CENTERED, 3 POSITION	
						Blocked Center	Exhaust Ports Open
C5	4-way 5/2 & 5/3	1/4 NPT G1/4	0.75	CGS-4232-NB1-†-(coil code) CGS-4292-NB1-†-(coil code) 	CGG-4232-NB1-†-(coil code) CGG-4292-NB1-†-(coil code) 	CXX-4233-NB1-†-(coil code) CXX-4293-NB1-†-(coil code) 	CXX-4234-NB1-†-(coil code) CXX-4294-NB1-†-(coil code) 
	3-way 3/2 & 3/3			CGS-3232-NB1-†-(coil code) CGS-3292-NB1-†-(coil code) 	CGG-3232-NB1-†-(coil code) CGG-3292-NB1-†-(coil code) 	CXX-3233-NB1-†-(coil code) CXX-3293-NB1-†-(coil code) 	CXX-3234-NB1-†-(coil code) CXX-3294-NB1-†-(coil code) 
C9	4-way 5/2 & 5/3	1/2 NPT	3.5	CGS-4532-NB1-†-(coil code) 	CGG-4532-NB1-†-(coil code) 	CXX-4533-NB1-†-(coil code) 	CXX-4534-NB1-†-(coil code) 
	3-way 3/2 & 3/3			CGS-3532-NB1-†-(coil code) 	CGG-3532-NB1-†-(coil code) 	CXX-3533-NB1-†-(coil code) 	CXX-3534-NB1-†-(coil code) 
C316	4-way 5/2 &	1/4 NPT	1.6	CGS-4332-316-NE1-†-(coil code) 	CGG-4332-316-NE1-†-(coil code) 	† Add suffix option here if required, For coil code see below.	* All valves include O ring interface seals and #10-24 mounting screws. E5, C5 & C9: For #10-32 screws change NB1 to NB2. For M5 screws change NB1 to NB3. C316 NAMUR: For #10-32 screws change NE1 to NE2. For M5 screws change NE1 to NE3. **3-way is the same body configuration as the 4-way, but has the cylinder port plug in the 3-way position. See "Note" in C5 section on page 6 for description.
	3-way 3/2			CGS-3331-316-NE1-†-(coil code) 	CGG-3331-316-NE1-†-(coil code) 		
E5	3-Way 3/2		0.08	E5SM-3011-34-NB1-†-(coil code) 			

<b>COIL CODES:</b> Identify the solenoid frequency and voltage; consisting of a "Rating Code" and "Voltage" as shown right. Coil codes complete the part number for a solenoid operated valve.	<b>Rating Code</b> A = 60Hz frequency D = Direct Current (DC) E = 50Hz frequency	<b>Voltage</b> Indicated by three digits: e.g. 24 volts = 024 120 volts = 120.	<b>A120 = AC, 120Volts/60hz</b>
--	---	---	---------------------------------

## NAMUR Actuator Speed Chart

This chart represents approximate actuator operation times under average load conditions at 80 psi (5.5 bar). Due to differing designs of quarter-turn actuators, breakaway friction, loading, internal airflow, inlet piping, fittings and exhaust port options, the values shown are intended as an estimate. Faster or slower times may actually be achieved.

		Actuator Volume in <sup>3</sup> (cm <sup>3</sup> )									
		Valve Type	5 (82)	10 (164)	25 (410)	50 (820)	100 (1640)	150 (2460)	200 (3280)	400 (6560)	600 (9840)
ACTUATOR CYCLE TIME IN SECONDS	C5	.32	.36	.47	.63	.98	1.3	1.7	3.1	4.5	7.2
	E5	.46	.64	1.1	2.0	3.9	5.7	7.5	-	-	-
	C-316	.19	.21	.25	.35	.55	.65	1.0	1.5	2.2	3.5

For double-acting actuators (open & close), use volume from selected actuator specifications and the chart for estimated speed. The times indicated are per shift. For spring return actuators, use open volume to obtain time from chart. Actuator spring loading may affect shift time. Slower speeds (adjustable) can always be accomplished by using Versa-act Bleed Control Valves in the control valve exhaust port.

# DIRECT MOUNT ACTUATOR VALVES

ALUMINUM

STAINLESS STEEL

## SERIES E5, C5, C9 & C316 Dimensions

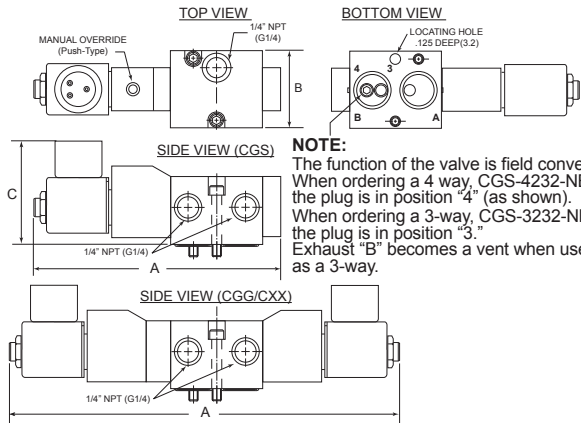

**NOTE:**  
The function of the valve is field convertible. When ordering a 4 way, CGS-4232-NB1 the plug is in position "4" (as shown). When ordering a 3-way, CGS-3232-NB1 the plug is in position "3." Exhaust "B" becomes a vent when used as a 3-way.

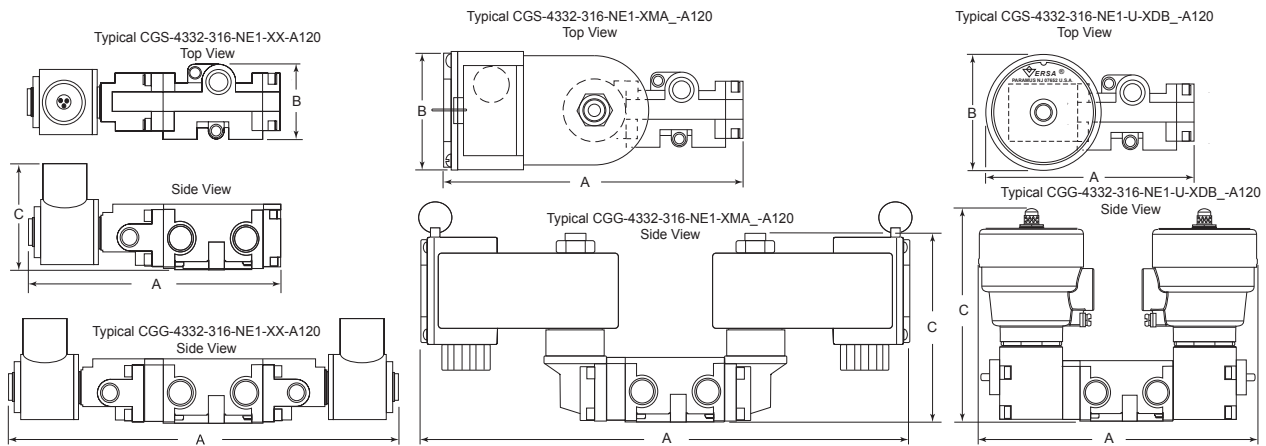
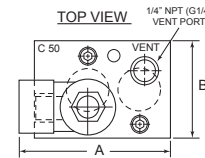
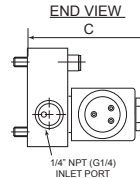

DIMENSIONS			Solenoid Options																				
VALVE* SERIES	Function	General Service						Hazardous Location															
		Standard, -228L			-027, 043			C50, -PC			-XX, -XN			-XISC, -XISX6			-XMA, XIF			-XDB			
		A	B	C	A	B	C	A	B	C	A	B	C	A	B	C	A	B	C	A	B	C	
E5	Single solenoid, spring return	2.11 (53.6)	1.75 (44)	2.31 (58.7)	—	—	—	2.84 (204.9)	1.75 (44)	2.31 (58.7)	3.01 (76.5)	2.47 (62.7)	2.39 (60.7)	2.8 (71)	1.89 (48.2)	1.75 (44)	—	—	—	—	—	—	—
C5	Single solenoid, spring return	5.02 (127.5)	1.56 (39.6)	1.29 (32.8)	3.45 (87.6)	1.56 (39.6)	2.34 (59.4)	5.02 (127.5)	1.04 (26.4)	2.09 (53.1)	3.79 (96.3)	1.31 (33.3)	1.45 (36.8)	3.53 (89.7)	1.31 (33.3)	1.15 (29.2)	—	—	—	—	—	—	—
C316	3-Way or 4-Way	5.56 (141.3)	1.63 (41.3)	2.15 (54.7)	—	—	—	5.56 (141.3)	1.63 (41.3)	2.15 (54.7)	5.56 (141.3)	1.63 (41.3)	2.32 (59)	5.43 (138)	1.63 (41.3)	2.94 (74.6)	6.59 (167.3)	2.56 (65)	4.13 (104.8)	4.63 (117.6)	2.50 (63.5)	4.74 (120.3)	
C5	Double solenoid	7.92 (201.1)	1.56 (39.6)	2.04 (51.8)	7.42 (188.4)	1.56 (39.6)	2.34 (59.4)	7.93 (201.4)	1.56 (39.6)	2.09 (53)	8.07 (205)	1.56 (39.6)	2.26 (57.4)	7.55 (191.7)	1.56 (39.6)	6.93 (176)	—	—	—	—	—	—	—
C316	3-Way or 4-Way	5.56 (141.3)	1.63 (41.3)	2.15 (54.7)	—	—	—	8.57 (217.7)	1.63 (41.3)	2.15 (54.6)	8.78 (223.1)	1.63 (41.3)	2.32 (59)	8.31 (211.1)	1.63 (41.3)	2.94 (74.6)	10.8 (275)	2.56 (65)	4.13 (104.8)	6.32 (160.5)	2.50 (63.5)	4.74 (120.3)	

\*For C9 consult factory

### Options

#### Overrides



Standard; momentary contact



-M; Unguarded, momentary contact

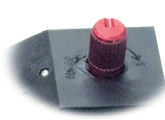

-CML; Knurled knob twist to lock

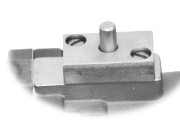

-ME; Unguarded, momentary contact

#### Solenoid Orientation

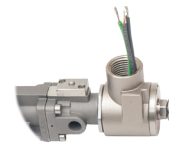

In line solenoid standard



Upright solenoid (-U)

Note: -U for C316 valves only

\*E5 not available with override

### Versa NAMUR ReBreather

Actuator Controls For Harsh Or Dirty Environments

#### Introduction

A valve accessory to protect valves and actuators from harsh and corrosive atmospheres. Designed to prevent the actuator spring chambers from sucking in external air and contaminants during the return stroke.

#### How it works

The ReBreather block is used on single acting actuators to prevent corrosive atmosphere from entering the actuator spring side. This add-on accessory is also designed to use available instrument air to fill spring side, thus assuring only clean air enters the actuator.

The instrument air it utilizes on the return stroke is the air from the exhaust cycle of the piston side of actuator. No additional air is required to complete the cycle and keep actuator clean, hence the reason this accessory is called a "ReBreather" -reusing clean exhaust air to keep actuator clean

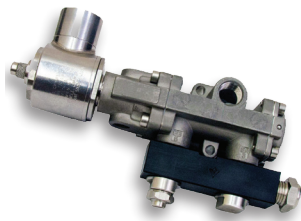

### Versa Dual Speed Control

Actuator Controls For Harsh Or Dirty Environments

#### Description

A simple device to control actuator speed in applications where the environment is corrosive from production, plant pollutants or other environmental issues. The Dual Speed Control Accessory protects the actuator package from external air and containments.

#### How it works

The Versa Dual Speed Control block is used on double acting actuators to prevent corrosive atmosphere from entering the valve package (actuator and solenoid NAMUR valve). This add-on

Accessory includes 2 of Versa's proven "Bleed Controls" to allow independent adjusting of open and close speeds.

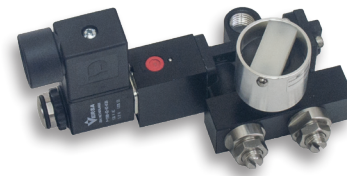

## ORDERING INFORMATION

As a Kit		
C Series	C 316 Series	Description
C-33RB-NB	C-33RB-NE	Plate, 1/4" NPT vent port open
C-33RB-NB-BC	C-33RB-NE-BC	Plate, and speed control, with 1/4" NPT vent port open
C-33RB-NB-DE3	C-33RB-NE-DE3	Plate, with DE-3 in vent port**
C-33RB-NB-BC-DE3	C-33RB-NE-BC-DE3	Plate, and speed control, with DE-3 in vent port
C-33RB-NB-MFS3	C-33RB-NE-MFS3	Plate, with MFS-3 in vent port
C-33RB-NB-BC-MFS3	C-33RB-NE-BC-MFS3	Plate, and speed control, with MFS-3 in vent port

On a Valve			
Suffix*	Description	Suffix*	Description
-RB	Plate, 1/4" NPT vent port open	-RB1	Plate, and speed control, with 1/4" NPT vent port open
-RB2	Plate, with DE-3 in vent port**	-RB3	Plate, and speed control, with DE-3 in vent port
-RB4	Plate, with MFS-3 in vent port	-RB5	Plate, and speed control, with MFS-3 in vent port

As a Kit		
C Series (-NB/-NX)	C 316 Series (-NE)	Description
C-43SC-NB	C-43SC-NE	Plate and speed controls with 1/4" NPT vent port open**
C-43SC-NB-DE3	C-43SC-NE-DE3	Plate and speed controls with DE-3 in vent port**
C-43SC-NB-MFS3	C-43SC-NE-MFS3	Plate and speed controls with MFS-3 in vent port**

On a Valve	
Suffix*	Description
-DBC	Plate and speed controls with 1/4" NPT vent port† for -NE valves
-DBC1	Plate and speed control with 1/4" NPT vent port† for NB/-NX valves
-DBC2	Plate and speed control with DE-3 in vent port for -NB/-NX valves
-DBC3	Plate and speed control with DE-3-316 in vent port for -NE valves
-DBC4	Plate for -NB/-NX valves. Bleed controls and MFS-3-316
-DBC5	Plate for -NE valves. Bleed controls and MFS-3-316

\*Add suffix to complete C/C-316 series valve part number.  
 \*\*Aluminum DE on C Series and Stainless on C-316 Series  
 † Customer supplied excluder

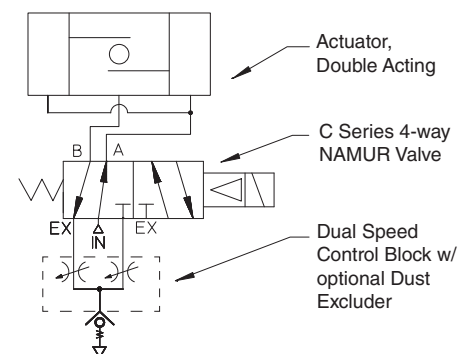
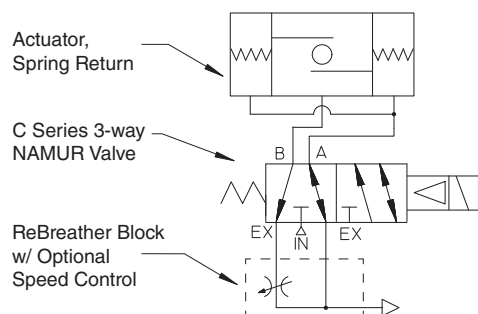



# BODYPORTED VALVES

STAINLESS STEEL CONSTRUCTION

## 3-WAY DIRECT ACTING SOLENOID VALVES

### General Description

The E4SM and E5SM are direct acting 3 port 2-Position (3/2), 1/8" or 1/4" NPT ported valves. The E4SM has a dedicated 316L solenoid housing with an integral junction box for Hazardous Locations with IEC, ATEX, INMETRO and North American agency approvals. The E5SM is available with plated steel or stainless steel solenoid housing with 24" leads standard. Agency approvals – ATEX and North America. Both valve series solenoid housings are available with 1/2" NPT or M20

conduit hub.

A variation of the valve type provides electrical quick exhaust valves E4QE and E5QE. These valves function the same as a 3-Way valve, but a larger capacity exhaust and rapid response to slight pressure differential during the de-energized portion of the cycle results in a more rapid evacuation of the controlled device than would be expected with a standard 3-Way valve.

3-WAY DIRECT SOLENOID VALVE PRODUCT NUMBER SELECTOR PNEUMATIC						PART NUMBERS* Single Solenoid/Spring Return, 2-Position				
AREA	FUNCTION	PRESSURE	FLOW Cv		POWER	SOLENOID ENCLOSURES				
		PSI (bar)	INLET	EXHAUST	(watts)	PLATED STEEL HOUSING	HIGH PERFORMANCE 430 STAINLESS STEEL	STAINLESS STEEL 316L WITH JUNCTION BOX		
NORTH AMERICA  CSA UL 1/2" NPT Conduit Hub (female)	3-Way Normally Closed	0-200 (14.0)	0.022	0.022	8.5 to 10.5	E5SM-3301-22-XXL4-(**)	E5SM-3301-22-XXE4-(**)	—		
		0-150 (10.0)	0.06	0.106		E5SM-3301-34-XXL4-(**)	E5SM-3301-34-XXE4-(**)			
		0-100 (6.9)	0.106	0.106		E5SM-3301-44-XXL4-(**)	E5SM-3301-44-XXE4-(**)			
		0-60 (4.1)	0.21	0.106		E5SM-3301-64-XXL4-(**)	E5SM-3301-64-XXE4-(**)			
		0-120 (8.3)	0.022	0.06	1.8	E5SM-3301-23-XXN4-(**)	E5SM-3301-23-XXJ4-(**)			
		0-60 (4.1)	0.06	0.06		E5SM-3301-33-XXN4-(**)	E5SM-3301-33-XXJ4-(**)			
		5-150 (0.3-10)	0.06	3.3		E5QE-30304-316-XXL4-(**)	E5QE-30304-316-XXE4-(**)			
		5-150 (0.3-10)	0.06	8.8		E5QE-50304-316-XXL4-(**)	E5QE-50304-316-XXE4-(**)			
	5-100 (0.3-6.9)	0.106	3.3	8.5 to 10.5	E5QE-30404-316-XXL4-(**)	E5QE-30404-316-XXE4-(**)				
	5-100 (0.3-6.9)	0.106	8.8		E5QE-50404-316-XXL4-(**)	E5QE-50404-316-XXE4-(**)				
	5-120 (0.3-8.3)	0.022	3.3		E5QE-30203-316-XXN4-(**)	E5QE-30203-316-XXJ4-(**)				
	5-120 (0.3-8.3)	0.022	8.8		E5QE-50203-316-XXN4-(**)	E5QE-50203-316-XXJ4-(**)				
	5-150 (0.3-10)	0.06	3.3	1.8	E5QE-30304-316-XXN4-(**)	E5QE-30303-316-XXJ4-(**)				
	5-150 (0.3-10)	0.06	8.8		E5QE-50304-316-XXN4-(**)	E5QE-50303-316-XXJ4-(**)				
	3-Way Normally Open	0-150 (10.0)	0.022		0.022	8.5 to 10.5	E5SM-3302-22-XXL-H-(**)	E5SM-3302-22-XXE-H-(**)	—	
		0-125 (8.6)	0.06		0.06		E5SM-3302-33-XXL-H-(**)	E5SM-3302-33-XXE-H-(**)		
0-100 (6.9)		0.106	0.106	E5SM-3302-44-XXL-H-(**)	E5SM-3302-44-XXE-H-(**)					
0-75 (5.2)		0.21	0.106	E5SM-3302-64-XXL-H-(**)	E5SM-3302-64-XXE-H-(**)					
0-200 (14.0)		0.022	0.022	8.5 to 10.5	E5SM-3301-22-XNL4-(**)	E5SM-3301-22-XNE4-(**)	—			
0-150 (10.0)		0.06	0.106		E5SM-3301-34-XNL4-(**)	E5SM-3301-34-XNE4-(**)				
0-100 (6.9)		0.106	0.106		E5SM-3301-44-XNL4-(**)	E5SM-3301-44-XNE4-(**)				
0-60 (4.1)		0.21	0.106		E5SM-3301-64-XNL4-(**)	E5SM-3301-64-XNE4-(**)				
0-120 (8.3)	0.022	0.06	1.8	E5SM-3301-23-XNN4-(**)	E5SM-3301-23-XNJ4-(**)					
0-60 (4.1)	0.06	0.06		E5SM-3301-33-XNN4-(**)	E5SM-3301-33-XNJ4-(**)					
5-150 (0.3-10)	0.06	3.3		E5QE-30304-316-XNL4-(**)	E5QE-30304-316-XNE4-(**)					
5-150 (0.3-10)	0.06	8.8		E5QE-50304-316-XNL4-(**)	E5QE-50304-316-XNE4-(**)					
5-100 (0.3-6.9)	0.106	3.3	8.5 to 10.5	E5QE-30404-316-XNL4-(**)	E5QE-30404-316-XNE4-(**)					
5-100 (0.3-6.9)	0.106	8.8		E5QE-50404-316-XNL4-(**)	E5QE-50404-316-XNE4-(**)					
5-120 (0.3-8.3)	0.022	3.3		E5QE-30203-316-XNN4-(**)	E5QE-30203-316-XNJ4-(**)					
5-120 (0.3-8.3)	0.022	8.8		E5QE-50203-316-XNN4-(**)	E5QE-50203-316-XNJ4-(**)					
5-150 (0.3-10)	0.06	3.3	1.8	E5QE-30304-316-XNN4-(**)	E5QE-30304-316-XNJ4-(**)					
5-150 (0.3-10)	0.06	8.8		E5QE-50304-316-XNN4-(**)	E5QE-50304-316-XNJ4-(**)					
3-Way Normally Open	0-150 (0.3-10)	0.022		0.022	8.5 to 10.5	E5SM-3302-22-XNL-H-(**)	E5SM-3302-22-XNE-H-(**)	—		
	0-125 (0.3-10)	0.06		0.06		E5SM-3302-33-XNL-H-(**)	E5SM-3302-33-XNE-H-(**)			
	0-100 (0.3-6.9)	0.106	0.106	E5SM-3302-44-XNL-H-(**)		E5SM-3302-44-XNE-H-(**)				
	0-75 (0.3-10)	0.21	0.106	E5SM-3302-64-XNL-H-(**)		E5SM-3302-64-XNE-H-(**)				
	North America 1/2" NPT female conduit hub (integral junction box)  CSA, ATEX, IECx, & INMETRO	3-Way Normally Closed	0-200 (13.8)	0.022	0.06	1.8	—		—	E4SM-3301-23-XDBT9-(**)
			0-175 (12.1)	0.06	0.106		E4SM-3301-34-XDBT9-(**)			
			0-125 (8.6)	0.106	0.106		E4SM-3301-44-XDBT9-(**)			
			0-75 (5.2)	0.21	0.106		E4SM-3301-64-XDBT9-(**)			
5-200 (0.3-13.7)			0.022	3.3	1.8	—	—	E4QE-30203-316-XDBT9-(**)		
5-200 (0.3-13.7)			0.022	8.8		E4QE-50203-316-XDBT9-(**)				
5-175 (0.3-12)		0.06	3.3	E4QE-30304-316-XDBT9-(**)						
5-175 (0.3-12)		0.06	8.8	E4QE-50304-316-XDBT9-(**)						
3-Way Normally Open		0-150 (10.3)	0.022	0.022	1.8	—	—	E4SM-3302-22-XDBT1-H2-(**)		
		0-100 (6.9)	0.06	0.06		E4SM-3302-33-XDBT1-H2-(**)				
		0-75 (5.2)	0.106	0.106		E4SM-3302-44-XDBT1-H2-(**)				
		0-50 (3.4)	0.21	0.106		E4SM-3302-64-XDBT1-H2-(**)				
	WORLD (d)Flameproof (e)Increased Safety M20 female conduit hub (integral Junctionbox)  CSA, ATEX, IECx, & INMETRO	3-Way Normally Closed	0-200 (13.8)	0.022	0.06	1.8	—	—	E4SM-3301-23-XDBS9-(**)	
			0-175 (12.1)	0.06	0.106		E4SM-3301-34-XDBS9-(**)			
0-125 (8.6)			0.106	0.106	E4SM-3301-44-XDBS9-(**)					
0-75 (5.2)			0.21	0.106	E4SM-3301-64-XDBS9-(**)					
5-200 (0.3-13.7)			0.022	3.3	1.8	—	—	E4QE-30203-316-XDBS9-(**)		
5-200 (0.3-13.7)			0.022	8.8		E4QE-50203-316-XDBS9-(**)				
5-175 (0.3-12)		0.06	3.3	E4QE-30304-316-XDBS9-(**)						
5-175 (0.3-12)		0.06	8.8	E4QE-50304-316-XDBS9-(**)						
3-Way Normally Open		0-150 (10.3)	0.022	0.022	1.8	—	—	E4SM-3302-22-XDBT1-H2-(**)		
		0-100 (6.9)	0.06	0.06		E4SM-3302-33-XDBT1-H2-(**)				
		0-75 (5.2)	0.106	0.106		E4SM-3302-44-XDBT1-H2-(**)				
		0-50 (3.4)	0.21	0.106		E4SM-3302-64-XDBT1-H2-(**)				

\* Part numbers shown are 1/4" NPT ported valves; for 1/8" NPT ports change seventh character in the part number from 3 to 2 example (E5SM-3302 to E5SM-3202)

\*\* Include voltage code (see top of page 27) † For Intrinsic Safe solenoids (see page 26).

# BODYPORTED VALVES Direct Acting

## Direct Acting Materials



### Materials

Valve Body:	430F Stainless steel	Screws (valve to actuator):	Stainless steel
Valve Seals:	Plunger and body – FKM (fluorocarbon) Valve/actuator – mounting O-rings –NBR (nitrile)	Solenoid Parts:	Sleeve, plunger & spring – 304, 430F & 302 stainless steel Coil Cover– solenoid housing: per solenoid option selected



E4SM-3201-22-XDBT9-D024



E5SM-3201-34-XXE4-D024



E4QE-50203-316-XDBT9-D024



E5QE-30304-316-XXL4-D024

## Direct Acting Dimensions

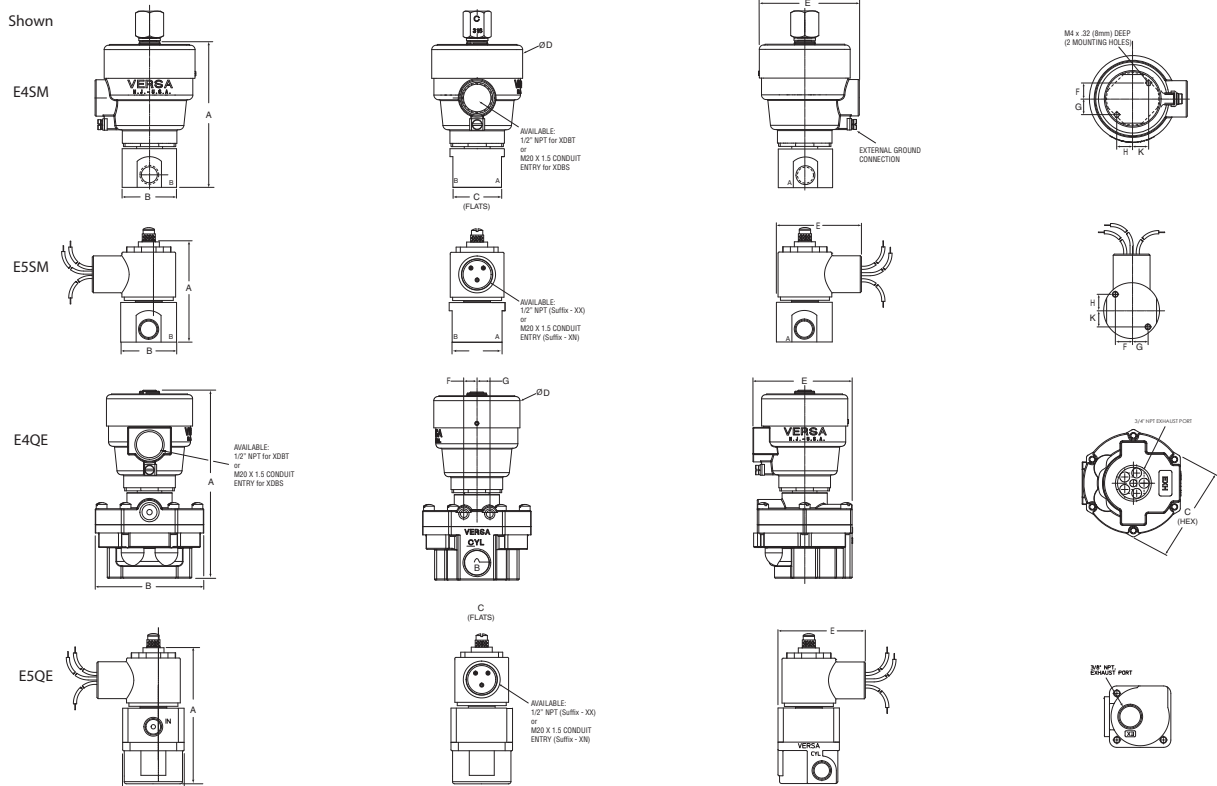

Manual overrides available see page 29

		DIMENSIONS										
		Ports		A	B	C	Ø D	E	F	G	H	K
E4SM	1/8" NPT	Inch	3.87	1	—	2.5	2.75	0.3	0.3	0.2	0.2	
		mm	98.2	25.4	—	63.5	69.9	7.5	7.5	5.2	5.2	
E5SM	1/4" NPT	Inch	4.03	1.5	1.34	2.5	2.75	0.44	0.44	—	—	
		mm	102.4	38.1	34.0	63.5	69.9	11.2	11.2	—	—	
E4QE	1/8" NPT	Inch	2.54	1	—	—	2.23	0.3	0.3	0.2	0.2	
		mm	64.5	25.4	—	—	56.6	7.5	7.5	5.2	5.2	
E5QE	1/4" NPT	Inch	2.71	1.5	1.34	—	2.26	0.44	0.44	—	—	
		mm	68.8	38.1	34.0	—	57.4	11.2	11.2	—	—	
E4QE	1/4" NPT Inlet & Outlet	Inch	5.45	—	2.75	2.69	0.38	0.38	2.85	—	—	
	3/4" NPT Exhaust	mm	138.5	—	69.9	75.2	9.5	9.5	72.4	—	—	
E5QE	1/4" NPT Inlet & Outlet	Inch	3.81	1.75	—	—	2.39	—	—	—	—	
	3/8" NPT Exhaust	mm	97	44.5	—	—	60.7	—	—	—	—	

# BODYPORTED VALVES

STAINLESS STEEL CONSTRUCTION

## SERIES D-316 3-Way Directing Acting Valve

The Versa Products Company D-316 Series valve is a high performance high flow direct acting solenoid valve. Designed as a 3-Way (3/2), it is a true multipurpose/universal flow valve. It is a “bubble tight” valve throughout its complete operating range and cycle life.

It is suitable for air, natural gas and hydraulic media. High performance stainless steels make the D-316 Series an ideal choice for the harshest environments. The D-316 can be configured for full NACE compliance. Ease of installation and field serviceability make the D-316 the choice for all applications.

### Valve/Conduit Positioning

Solenoid housing rotates 360° without need for tools, disassembly or valve re-adjustment. The D-316 high performance valve can be mounted in any orientation for simplified installation and connection. Reducing installation cost and labor.

### Integral Junction Box

O-Ring sealing for solenoid enclosure provides a fully weather protected solenoid and integral junction box. Ratings of IP66/67/68 rating and NEMA 6P ( prolonged submersion) assures long trouble free life in wet environments. A high temperature rated terminal strip is included simplifying and protecting wiring connections.

### Poppet

Universal high flow balanced poppet design is maximized through a unique sealing design. The balanced design assures no false shifts due to pressure spikes regardless of application pressures. Universal flow provides all functions in one valve.

### Specifications

Actuation:	Solenoid actuated, spring return
Function:	3/2, 3-Way, 2-Position, universal flow
Media:	Pneumatic, Air/Inert gas and Hydraulic
Pressure:	vac to 175psi (vac to 12 bar)
Flow:	0.8 Cv
Temperature:	+4°F to 194°F (-20°C to 90°C) -40°F to 194°F (-40°C to 90°C), low temp buna option -44 -62°F to 194°F (-52°C to 90°C), Fluorosilicone option -T40 For lower temperature consult factory
Port size:	¼" NPT

### Voltage/Power:

Voltage	Power	Ordering code		
		DC	AC 60 Hz	AC 50 Hz
12 VDC 24 VDC 125 VDC	2.6 watts	-D012 -D024 -D125	—	—
110/120 VAC 220/240 VAC	3.1 watts	—	-A120 -A240	-E110 -E220

Coil class:	H Class
Surge protection:	None, standard Diode, suffix -303D. DC only Metal-oxide varistor (MOV), suffix -303. AC or DC
Connections:	½" NPT or M20 conduit hub
Ingress protection:	IP66/67/68 & NEMA 4, 4X & 6P

### Materials of construction\*:

Body:	316L Stainless Steel
Poppet:	316L Stainless Steel
Coil Housing:	316L Stainless Steel
Coil:	Epoxy molded
Seals	FKM: Fluorocarbon, standard

\*All valve components comply with NACE MR0175 except for main spring which is 316 stainless steel.  
All wetted parts are NACE Compliant. For full NACE compliance, add option -NA for Inconel spring.



DSM-3301-316-M-XDDT-D024  
DSM-3301-316-M5R-XDDT-D024



DSM-3301-316-XDDT-356BN-D024



# BODYPORTED VALVES D316

## The D-316 Series Dimensions



### Solenoid Type

Solenoid Type	Suffix Number	Rating	Agency	Connection
World Solenoid	-XDDS	Ex II 2 G D Ex d IIC T4 Gb Ex tb IIIC IP66 T4 °C Db Cl, I Zn 1, A/Ex d e IIC Cl, II, Zn 21, AEx tD A21, T4 °C	ATEX IECEX  cCSA <sub>US</sub>	M20
World Solenoid North American rating	-XDDT	Ex II 2 G D Ex d IIC T4 Gb Ex tb IIIC IP66 T4 °C Db  Ex d IIC T4, Cl I, Zn 1, AEx d IIC T4 Zone 21, AEx tb IIIC T4 Db Type 4X, 6P, IP66/68 Cl I Div 1, Grps B, C & D Cl II Div 1 Grps E, F & G Cl III T4 Cl I Div 2, Grps A, B, C & D T4	ATEX IECEX  cCSA <sub>US</sub>	½" NPT

For other "T" ratings consult factory

### Valve Type - Options

Valve Type & Options	Part Number	Weight
Solenoid Operated-Spring return	DSM-3301-316-XDD*-(**)	5.1 lbs (2.3 kg)
Solenoid Operated-Spring return with Non-locking override, unguarded	DSM-3301-316-M-XDD*-(**)	5.2 lbs (2.4 kg)
Solenoid Operated-Spring return with Locking override, unguarded	DSM-3301-316-M5R-XDD*-(**)	5.2 lbs (2.4 kg)
Solenoid Operated-Spring return with Non-locking override, guarded	DSM-3301-316-G-XDD*-(**)	5.2 lbs (2.4 kg)
Solenoid Operated-Spring return with Locking override, guarded	DSM-3301-316-G5R-XDD*-(**)	5.2 lbs (2.4 kg)
Solenoid Operated-Spring return with Latching reset	DSM-3301-316-XDD*-356BN-(**)	5.4 lbs (2.4 kg)
Solenoid Operated-Spring return with Latching reset and manual button	DSM-3301-316-XDD*-356B-(**)	5.6 lbs (2.5 kg)

\* Select Suffix Number: XDDS for M20 conduit hub or XDDT for ½" NPT conduit hub. See "Solenoid Type" chart above

\*\*Select voltage from "Voltage/Power" chart left.

### Dimensions

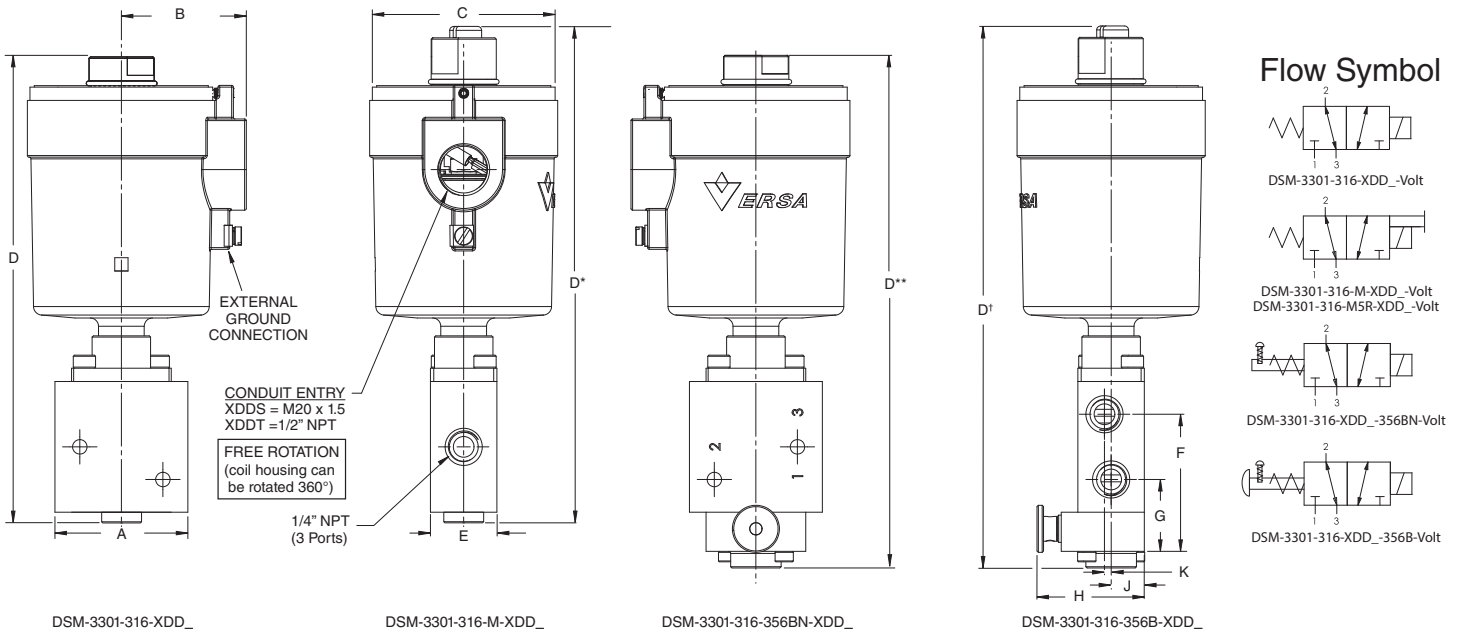

DSM-3301-316-XDD\_

DSM-3301-316-M-XDD\_

DSM-3301-316-356BN-XDD\_

DSM-3301-316-356B-XDD\_

	A	B	C Ø	D	D*	D**	D†	E	F	G	H	J	K
DSM-3301-316-XDD_-Volts	2 50.8	1.87 47.5	2.83 71.9	7 177.8	—	—	—	1 25.4	2.06 52.3	1.08 27.5	—	0.5 12.7	0.10 2.54
DSM-3301-316-M-XDD_-Volts	2 50.8	1.87 47.5	2.83 71.9	—	7.5 190.5	—	—	1 25.4	2.06 52.3	1.08 27.5	—	0.5 12.7	0.10 2.54
DSM-3301-316-356B-XDD_-Volts	2 50.8	1.87 47.5	2.83 71.9	—	—	7.7 196	—	1 25.4	2.06 52.3	1.08 27.5	1.62 41	0.5 12.7	0.10 2.54
DSM-3301-316-356BN-XDD_-Volts	2 50.8	1.87 47.5	2.83 71.9	—	—	—	8.16 207.3	1 25.4	2.06 52.3	1.08 27.5	1.62 41	0.5 12.7	0.10 2.54

# BODYPORTED VALVES

ALUMINUM CONSTRUCTION

## SERIES C5,C7 & C9 Bodyported 3-Way/4-Way Solenoid Valves

### General Description

Versa C5, C7 series are 3-Way and 4-Way, 2 and 3 position and the C9 series is 4-Way\*, 2 and 3 position, all are high flow, body ported, solenoid/pilot valves. They can be provided with single or double solenoid actuators. Manual override (guarded-push to operate, turn to lock) is standard on all models. Other options are available. Actuator positioning is possible with the use of 3-position valves since all C5, C7 and C9 valves are leak free/bubbletight.



The standard valve is supplied with DIN style coil, but other options are available making the most exacting and demanding specifications or applications easy to satisfy.

\* 3-Way valve can be created by plugging one port of a 4-Way.

### Materials

Valve Body and Plunger:	Anodized aluminum
Actuating Caps:	Solenoid – anodized aluminum spring cap – synthetic resin
Pilot Piston:	Synthetic resin
Valve Seals:	Plunger and body – FKM (fluorocarbon) Pilot piston – NBR (nitrile)
Screws:	Stainless steel
Solenoid Parts:	Sleeve, plunger & spring – 304 & 430F stainless steel Coils – epoxy molded with 3 spade terminals (std), or 2 or 3 wire leads (opt). Coil cover (opt.-when applicable) plated steel

### Port Size

Inlet,	C5	1/8 NPT or G1/8-Series
outlet and	C7	1/4 NPT or G1/4-Series
exhaust	C9	1/2 NPT or G1/2-Series

## C5/C7/C9 Bodyported Valve Product Number Selector

FUNCTION	SIZE SERIES	PORT SIZE	Cv	Basic Valve Number*			
				SINGLE SOLENOID/SPRING RETURN, 2-POSITION	DOUBLE SOLENOID/DETENT, 2-POSITION	DOUBLE SOLENOID/SPRING CENTERED, 3-POSITION	
						BLOCKED CENTER	EXHAUST PORTS OPEN
3-Way 3/2 NC & 3/3	C5	1/8 NPT G1/8"	0.75 0.75	CSG-3221-†-(coil code) CSG-3281-†-(coil code)	CGG-3221-†-(coil code) CGG-3281-†-(coil code)	CXX-3223-†-(coil code) CXX-3283-†-(coil code)	
	C7	1/4" NPT G1/4"	1.5 1.5	CSG-3321-†-(coil code) CSG-3381-†-(coil code)	CGG-3321-†-(coil code) CGG-3381-†-(coil code)	CXX-3323-†-(coil code) CXX-3383-†-(coil code)	---
3-Way 3/2 NO & 3/3	C5	1/8 NPT G1/8"	0.75 0.75	CGS-3222-†-(coil code) CGS-3282-†-(coil code)	SEE ABOVE	SEE ABOVE	---
	C7	1/4" NPT G1/4"	1.5 1.5	CGS-3322-†-(coil code) CGS-3382-†-(coil code)			
4-Way 5/2 & 5/3	C5	1/8 NPT G1/8"	0.75 0.75	CSG-4222-†-(coil code) CSG-4282-†-(coil code)	CGG-4222-†-(coil code) CGG-4282-†-(coil code)	CXX-4223-†-(coil code) CXX-4283-†-(coil code)	CXX-4224-†-(coil code) CXX-4284-†-(coil code)
	C7	1/4" NPT G1/4"	1.5 1.5	CSG-4322-†-(coil code) CSG-4382-†-(coil code)	CGG-4322-†-(coil code) CGG-4382-†-(coil code)	CXX-4323-†-(coil code) CXX-4383-†-(coil code)	CXX-4324-†-(coil code) CXX-4384-†-(coil code)
	C9	1/2" NPT G1/2"	4.1 4.1	CSG-4522-†-(coil code) CSG-4582-†-(coil code)	CGG-4522-†-(coil code) CGG-4582-†-(coil code)	CXX-4523-†-(coil code) CXX-4583-†-(coil code)	CXX-4524-†-(coil code) CXX-4584-†-(coil code)

For coil code see page 5.

† Add suffix here, if required.

### Operating Pressure

Valve Type	Size Series	Operating Pressure Range** (Pneumatic)
Single Solenoid/spring return (2-Position)	C5	15-115 psi(1-8 bar)
	C7	25-115 psi(1.7-8 bar)
	C9	30-150 psi (2.1-10.3 bar)
Double Solenoid/detented (2-Position)	C5	10-115 psi(0.7-8 bar)
	C7	15-115 psi(1-8 bar)
	C9	20-150 psi(1.4-10.3 bar)
Double Solenoid/spring centered (3-position)	C5	15-115 psi(1-8 bar)
	C7	25-115 psi(1.7-8 bar)
	C9	30-150 psi (2.1-10.3 bar)

\*\* Pressure ranges may change based on solenoid option. For higher pressure applications, consult factory.

### Installation, Filtration and Lubrication

Valves:	No limitations on mounting orientation.
Filtration:	40 to 50 micron
Lubrication:	General purpose lubricating oil ISO, ASTM viscosity grade 32

### Options Suffix

Manual Override:	Standard on basic valves, guarded-push to operate, turn to lock. -CML: unguarded-push to operate, twist to lock
------------------	--

For solenoid options see page 25 - 29

# BODYPORTED VALVES

## C5, C7 & C9 Dimensions



### THREE-WAY

### BODY DETAIL

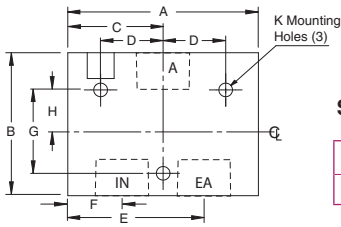

Series	Port Size	A		B		C		D		E		F		G		HØ	
		in	mm	in	mm	in	mm	in	mm	in	mm	in	mm	in	mm	in	mm
C5	1/8"	1.31	33.3	1.47	37.2	0.66	16.7	0.65	36.4	0.5	12.7	0.34	8.7	0.66	16.7	0.14	3.7
C7	1/4"	2	50.8	1.5	38.1	1.0	24.5	0.66	16.7	1.43	36.3	0.57	14.5	0.88	22.2	0.14	3.7

### SINGLE SOLENOID

### DOUBLE SOLENOID

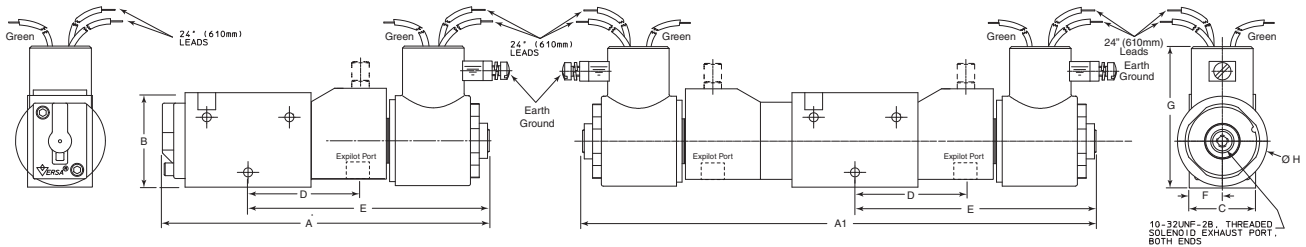

Series	Port Size	A		A1		B		C		D		E		F		G		HØ	
		in	mm	in	mm	in	mm	in	mm	in	mm	in	mm	in	mm	in	mm	in	mm
C5	1/8"	4.53	115.0	7.49	190.2	1.47	37.3	0.88	22.4	0.66	16.8	3.48	88.4	0.44	11.2	1.51	38.4	1.44	36.6
C7	1/4"	5.22	132.5	8.19	208	1.5	38.1	1.06	26.9	1.75	44.5	3.84	88.4	0.53	13.5	1.51	38.4	1.44	36.6

\*Dimensions for Spring-Centering Valves. NOTE: Adapter is supplied when specified by adding suffix "-H" to product number

### FOUR-WAY

### BODY DETAIL

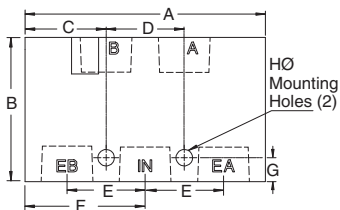

Series	Port Size	A		B		C		D		E		F		G		HØ	
		in	mm	in	mm	in	mm	in	mm	in	mm	in	mm	in	mm	in	mm
C5	1/8"	1.88	47.6	1.25	31.6	0.63	16.0	0.62	15.7	0.63	16.0	0.94	23.9	0.24	6.0	0.14	3.6
C7	1/4"	2.5	63.5	1.5	38.1	0.84	21.3	0.81	20.6	0.81	20.6	1.25	31.8	0.25	6.4	0.14	3.6
C9	1/2"	4	101.6	2.25	57.2	1.38	35.1	1.25	31.8	1.25	31.8	2.0	50.8	0.38	9.7	0.27	6.9

### SINGLE SOLENOID

### DOUBLE SOLENOID

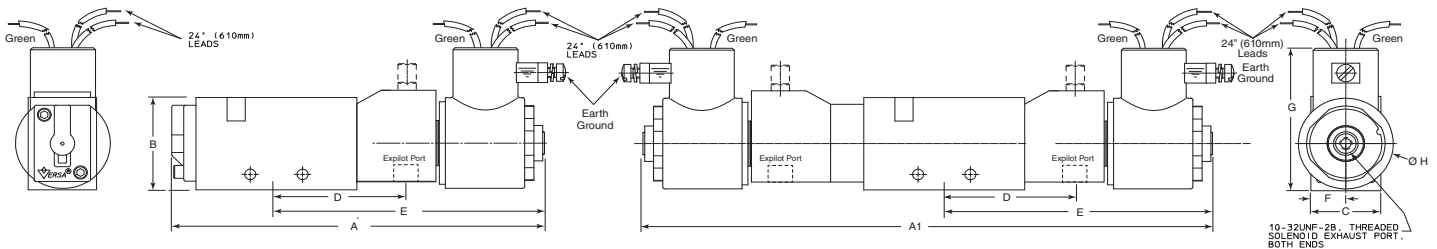

Series	Port Size	A		A1		B		C		D		E		F		G		HØ	
		in	mm	in	mm	in	mm	in	mm	in	mm	in	mm	in	mm	in	mm	in	mm
C5	1/8"	4.53	115.0	7.49	190.2	1.47	37.3	0.88	22.4	0.66	16.8	3.48	88.4	0.44	11.2	1.51	38.4	1.44	36.6
C7	1/4"	5.22	132.5	8.19	208	1.5	38.1	1.06	26.9	1.75	44.5	3.84	88.4	0.53	13.5	1.51	38.4	1.44	36.6
C9	1/2"	7.53	191	11.18	284	2.25	57.2	2	50.8	3	76.2	4.91	124.7	0.86	21.8	2.67	67.8	1.44	36.6



# BODYPORTED VALVES

BRASS CONSTRUCTION

## SERIES V Bodyported 3-Way & 4-Way Solenoid Valves

### General Description

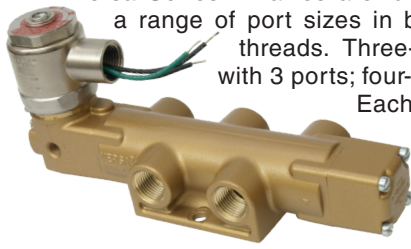

Versa Series V valves are full flow valves, available in a range of port sizes in both NPT or ISO 228 "G" threads. Three-way designs are provided with 3 ports; four-way designs have 5 ports. Each is available for 2-position or 3-position service. Standard size O-ring seals provide bubbletight sealing and ease of service.

Each valve is solenoid/pilot actuated, which enables the use of physically small solenoids providing low power consumption, and also assures a strong positive shifting force without fear of coil burn-out. A complete selection of electrical connections, area classifications, and power requirements makes the most exacting and demanding specifications or applications easy to satisfy.

### Materials

Valve Body:	Forged brass
Internal parts (wetted):	Rod brass
Actuating Caps:	Solenoid – forged brass spring cap – die-cast aluminum
Valve Seals:	NBR (nitrile), standard size O-rings
Screws:	Screws: zinc plated steel
Solenoid Parts:	Sleeve, plunger & spring – 304 & 430F stainless steel Coils – epoxy molded with 3 spade terminals (std), or 2 or 3 wire leads (opt). Coil cover (opt.-when applicable) plated steel

### Port Size

Inlet, outlet and exhaust	1/8" NPT or G1/8-Series 1/4" NPT or G1/4-Series 3/8" NPT or G3/8-Series 1/2" NPT or G1/2-Series 3/4" NPT 1" NPT
---------------------------	--

## Series V Bodyported Valve Product Number Selector

		BASIC VALVE NUMBER				
FUNCTION	PORT SIZE (NPT)*	Flow C <sub>v</sub>	SINGLE SOLENOID/SPRING RETURN 2-POSITION	DOUBLE SOLENOID/MOMENTARY CONTACT 2-POSITION	DOUBLE SOLENOID/SPRING CENTERED 3-POSITION	
					BLOCKED CENTER	EXHAUST PORTS OPEN
3-Way, 3/2 Normally Closed	1/8"	1.4	VSG-3221-U-(coil code)	VGG-3221-U-(coil code)	VXX-3223-U-(coil code)	—
	1/4"	1.8	VSG-3321-U-(coil code)	VGG-3321-U-(coil code)	VXX-3323-U-(coil code)	
	3/8"	3.4	VSG-3421-U-(coil code)	VGG-3421-U-(coil code)	VXX-3423-U-(coil code)	
	1/2"	4.0	VSG-3521-U-(coil code)	VGG-3521-U-(coil code)	VXX-3523-U-(coil code)	
	3/4"	9.7	VSG-3621-U-(coil code)	VGG-3621-U-(coil code)	VXX-3623-U-(coil code)	
3-Way, 3/3 Three Position	1"	11.1	VSG-3721-U-(coil code)	VGG-3721-U-(coil code)	VXX-3723-U-(coil code)	
3-Way, 3/2 Normally Open	1/8"	1.4	VGS-3222-U-(coil code)	SEE ABOVE	SEE ABOVE	—
	1/4"	1.8	VGS-3322-U-(coil code)			
	3/8"	3.4	VGS-3422-U-(coil code)			
	1/2"	4.0	VGS-3522-U-(coil code)			
	3/4"	9.7	VGS-3622-U-(coil code)			
3-Way, 3/3 Three Position	1"	11.1	VGS-3722-U-(coil code)			
4-Way, 5/2 & 5/3	1/8"	1.4	VSG-4222-U-(coil code)	VGG-4222-U-(coil code)	VXX-4223-U-(coil code)	VXX-4224-U-(coil code)
	1/4"	1.8	VSG-4322-U-(coil code)	VGG-4322-U-(coil code)	VXX-4323-U-(coil code)	VXX-4324-U-(coil code)
	3/8"	3.4	VSG-4422-U-(coil code)	VGG-4422-U-(coil code)	VXX-4423-U-(coil code)	VXX-4424-U-(coil code)
	1/2"	4.0	VSG-4522-U-(coil code)	VGG-4522-U-(coil code)	VXX-4523-U-(coil code)	VXX-4524-U-(coil code)
	3/4"	9.7	VSG-4622-U-(coil code)	VGG-4622-U-(coil code)	VXX-4623-U-(coil code)	VXX-4624-U-(coil code)
4-Way, 5/2 & 5/3	1"	11.1	VSG-4722-U-(coil code)	VGG-4722-U-(coil code)	VXX-4723-U-(coil code)	VXX-4724-U-(coil code)

For coil code see page 5.

\* Valves with ISO 228 "G" threads have same Cv flow factors as corresponding NPT port sizes. To indicate model number of valves with "G" thread, add suffix "-2B" to basic valve number shown. For example: VSG-3221-U becomes VSG-3221-U-2B.

### Operating Pressure

Valve Type	Port Size	Operating Pressure Range <sup>†</sup> (Pneumatic)
Single Solenoid/spring return (2-Position)	1/8, 1/4, 3/8 or 1/2	40-175 psi (2.8-12 bar)
	3/4 or 1	50-175 psi (3.5-12 bar)
Double Solenoid/momentary contact (2-Position)	1/8, 1/4, 3/8 1/2, 3/4 or 1	20-175 psi (1.4-12 bar)
Double Solenoid/spring centered (3-position)	1/8, 1/4, 3/8 or 1/2	40-175 psi (2.8-12 bar)
	3/4 or 1	50-175 psi (3.5-12 bar)

### Installation, Filtration and Lubrication

Valves:	No limitations on mounting orientation.
Filtration:	40 to 50 micron
Lubrication:	General purpose lubricating oil ISO, ASTM viscosity grade 32

# BODYPORTED VALVES

## Bodyported Series V Dimensions†



### THREE-WAY

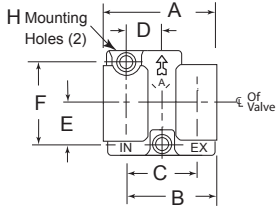

### BODY DETAIL

SIZE NPT or G	A		B		C		D		E		F		HØ	
	in	mm	in	mm	in	mm	in	mm	in	mm	in	mm	in	mm
1/8 - 1/4	2 <sup>3</sup> / <sub>16</sub>	56	1 <sup>3</sup> / <sub>4</sub>	44	1 <sup>5</sup> / <sub>16</sub>	33	2 <sup>1</sup> / <sub>32</sub>	17	5 <sup>1</sup> / <sub>64</sub>	20	1 <sup>19</sup> / <sub>32</sub>	40	.256	6.5
3/8 - 1/2	3 <sup>3</sup> / <sub>4</sub>	95	2 <sup>7</sup> / <sub>8</sub>	73	2	51	1	25	1 <sup>1</sup> / <sub>8</sub>	29	2 <sup>1</sup> / <sub>4</sub>	57	.328	8
3/4 - 1	5 <sup>1</sup> / <sub>2</sub>	140	4 <sup>1</sup> / <sub>4</sub>	108	3	76	1 <sup>1</sup> / <sub>2</sub>	38	1 <sup>9</sup> / <sub>16</sub>	40	3 <sup>3</sup> / <sub>8</sub>	79	.390	10

### SINGLE SOLENOID

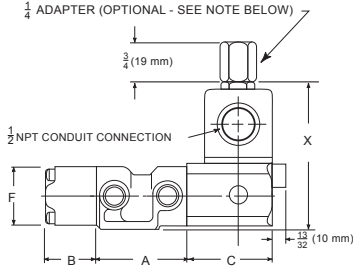

### DOUBLE SOLENOID

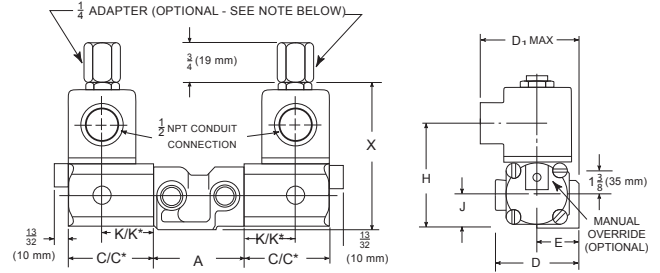

SIZE NPT or G	A		B		C		C*		D1		D		E		F		H		J		K		K*		X	
	in	mm	in	mm	in	mm	in	mm	in	mm	in	mm	in	mm	in	mm	in	mm	in	mm	in	mm	in	mm	in	mm
1/8 - 1/4	2 <sup>3</sup> / <sub>16</sub>	56	1 <sup>7</sup> / <sub>32</sub>	31	2 <sup>3</sup> / <sub>32</sub>	53	3	76	2 <sup>1</sup> / <sub>2</sub>	64	2	51	1	25	1 <sup>1</sup> / <sub>2</sub>	38	2 <sup>19</sup> / <sub>32</sub>	66	1 <sup>13</sup> / <sub>16</sub>	21	1 <sup>9</sup> / <sub>32</sub>	33	2 <sup>3</sup> / <sub>16</sub>	56	3 <sup>13</sup> / <sub>16</sub>	97
3/8 - 1/2	3 <sup>3</sup> / <sub>4</sub>	95	1 <sup>7</sup> / <sub>32</sub>	31	2 <sup>3</sup> / <sub>32</sub>	53	3	76	2 <sup>7</sup> / <sub>8</sub>	73	2 <sup>3</sup> / <sub>4</sub>	70	1 <sup>9</sup> / <sub>8</sub>	35	1 <sup>11</sup> / <sub>16</sub>	43	2 <sup>21</sup> / <sub>32</sub>	67	7 <sup>7</sup> / <sub>8</sub>	22	1 <sup>9</sup> / <sub>32</sub>	33	2 <sup>3</sup> / <sub>16</sub>	56	3 <sup>7</sup> / <sub>8</sub>	98
3/4 - 1	5 <sup>1</sup> / <sub>2</sub>	140	2 <sup>1</sup> / <sub>16</sub>	52	2	51	3 <sup>15</sup> / <sub>32</sub>	88	3 <sup>3</sup> / <sub>8</sub>	86	3 <sup>3</sup> / <sub>4</sub>	95	1 <sup>7</sup> / <sub>8</sub>	48	2 <sup>7</sup> / <sub>16</sub>	62	3 <sup>29</sup> / <sub>32</sub>	99	1 <sup>1</sup> / <sub>4</sub>	32	1	25	2 <sup>1</sup> / <sub>2</sub>	64	5 <sup>5</sup> / <sub>32</sub>	131

\*Dimensions for Spring-Centering Valves. NOTE: Adapter is supplied when specified by adding suffix "-H" to product number

### FOUR-WAY

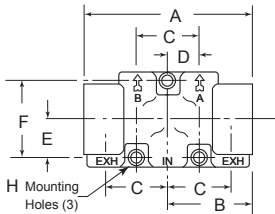

### BODY DETAIL

SIZE NPT or G	A		B		C		D		E		F		HØ	
	in	mm	in	mm	in	mm	in	mm	in	mm	in	mm	in	mm
1/8 - 1/4	3 <sup>1</sup> / <sub>2</sub>	89	1 <sup>3</sup> / <sub>4</sub>	44	1 <sup>5</sup> / <sub>16</sub>	33	2 <sup>1</sup> / <sub>32</sub>	17	5 <sup>1</sup> / <sub>64</sub>	20	1 <sup>19</sup> / <sub>32</sub>	40	.256	6.5
3/8 - 1/2	5 <sup>3</sup> / <sub>4</sub>	146	2 <sup>7</sup> / <sub>8</sub>	73	2	51	1	25	1 <sup>1</sup> / <sub>8</sub>	29	2 <sup>1</sup> / <sub>4</sub>	57	.328	8
3/4 - 1	8 <sup>1</sup> / <sub>2</sub>	216	4 <sup>1</sup> / <sub>4</sub>	108	3	76	1 <sup>1</sup> / <sub>2</sub>	38	1 <sup>9</sup> / <sub>16</sub>	40	3 <sup>3</sup> / <sub>8</sub>	79	.390	10

### SINGLE SOLENOID

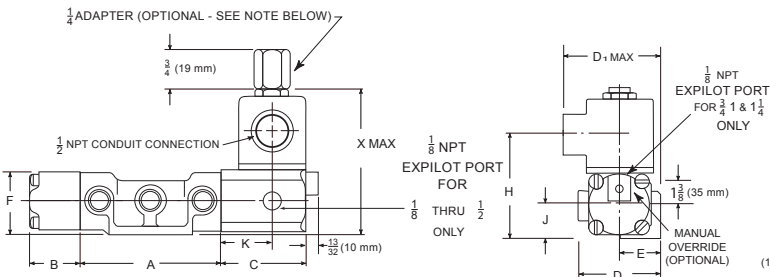

### DOUBLE SOLENOID

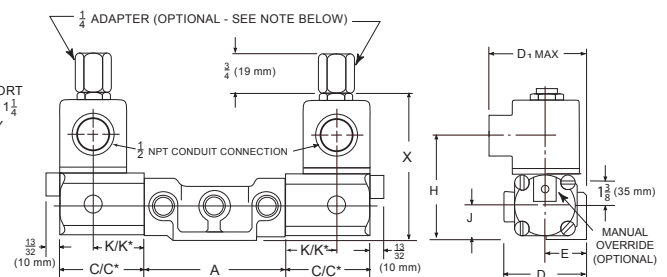

SIZE NPT or G	A		B		C		C*		D1		D		E		F		H		J		K		K*		X	
	in	mm	in	mm	in	mm	in	mm	in	mm	in	mm	in	mm	in	mm	in	mm	in	mm	in	mm	in	mm	in	mm
1/8 - 1/4	3 <sup>1</sup> / <sub>2</sub>	89	1 <sup>7</sup> / <sub>32</sub>	31	2 <sup>3</sup> / <sub>32</sub>	53	3	76	2 <sup>1</sup> / <sub>2</sub>	64	2	51	1	25	1 <sup>1</sup> / <sub>2</sub>	38	2 <sup>19</sup> / <sub>32</sub>	66	1 <sup>13</sup> / <sub>16</sub>	21	1 <sup>9</sup> / <sub>32</sub>	33	2 <sup>3</sup> / <sub>16</sub>	56	3 <sup>13</sup> / <sub>16</sub>	97
3/8 - 1/2	5 <sup>3</sup> / <sub>4</sub>	146	1 <sup>7</sup> / <sub>32</sub>	31	2 <sup>3</sup> / <sub>32</sub>	53	3	76	2 <sup>7</sup> / <sub>8</sub>	73	2 <sup>3</sup> / <sub>4</sub>	70	1 <sup>9</sup> / <sub>8</sub>	35	1 <sup>11</sup> / <sub>16</sub>	43	2 <sup>21</sup> / <sub>32</sub>	67	7 <sup>7</sup> / <sub>8</sub>	22	1 <sup>9</sup> / <sub>32</sub>	33	2 <sup>3</sup> / <sub>16</sub>	56	3 <sup>7</sup> / <sub>8</sub>	98
3/4 - 1	8 <sup>1</sup> / <sub>2</sub>	216	2 <sup>1</sup> / <sub>16</sub>	52	2	51	3 <sup>15</sup> / <sub>32</sub>	88	3 <sup>3</sup> / <sub>8</sub>	86	3 <sup>3</sup> / <sub>4</sub>	95	1 <sup>7</sup> / <sub>8</sub>	48	2 <sup>7</sup> / <sub>16</sub>	62	3 <sup>29</sup> / <sub>32</sub>	99	1 <sup>1</sup> / <sub>4</sub>	32	1	25	2 <sup>1</sup> / <sub>2</sub>	64	5 <sup>5</sup> / <sub>32</sub>	131

\*Dimensions for Spring-Centering Valves. NOTE: Adapter is supplied when specified by adding suffix "-H" to product number

†Dimensions shown are for basic valve as listed on previous page. Some options may change the dimensions, for which consult factory.

# BODYPORTED VALVES

STAINLESS STEEL CONSTRUCTION

## SERIES C-316 Bodyported 3-Way & 4-Way Solenoid Valves

### General Description

Versa Series C-316 stainless steel valve is a high flow, 3 or 5 port solenoid valve that utilizes a fluorocarbon elastomer seal packed plunger that provides bubbletight performance with long, trouble-free product life. The design also provides the highest flow in the smallest package. Stainless steel bodies, actuating caps and internal parts allow use in the most aggressive environments.

The C-316 Series is available as 4-Way, for double acting devices, or 3-Way for spring return devices. The 3-Way function can be specified as either normally open or normally closed. All solenoid actuators are solenoid/pilot type,

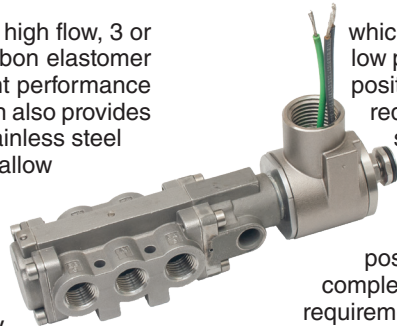

which allows the use of small solenoids resulting in low power consumption. Solenoid/pilots also provide a positive shifting force that assures the valve shifts, thus reducing the chance of coil burnout. Single solenoid-spring return models utilize an air assisted return feature assuring a positive return.

Double solenoid models are equipped with a detent that maintains the valve in the last shifted position, even in high vibration environments. A complete selection of electrical connections, power requirements and area classifications makes the Versa C-316 the valve of choice for demanding applications.

### Materials

Valve Body and Plunger:	316L stainless steel
Actuating Caps:	316L stainless steel
Pilot Piston:	316L stainless steel
Valve Seals:	Plunger and body – FKM (fluorocarbon)
Screws:	Stainless steel
Solenoid Parts:	Sleeve, plunger & spring – 304 & 430F stainless steel Coils – solenoid housing: per solenoid option selected

### PortSize

Inlet, Outlet and Exhaust	1/4" NPT
---------------------------	----------

### Flow Rates

Inlet, Outlet and Exhaust	Cv 2.0
---------------------------	-----------

### Options

Manual Override	-ME; unguarded-push to operate
-----------------	--------------------------------

### Operating Pressures

Valve Type	Operating Pressure Range Pneumatic
Single Solenoid-Spring Return	25 to 150 psi (1.8 to 10.3 bar)
Single Solenoid-Latching 3-Way	25 to 150 psi (1.8 to 10.3 bar)
Double Solenoid-Detented	15 to 150 psi (1.0 to 10.3 bar)

### Installation and Filtration

Valves:	No limitations on mounting orientation.
Filtration:	40 to 50 micron

### Series C-316 BODYPORTED VALVE Product Number Selector

Basic Valve Number					
FUNCTION	SINGLE SOLENOID/SPRING RETURN, 2-POSITION	DOUBLE SOLENOID DETENT, 2-POSITION	LATCHING, SINGLE SOLENOID SPRING RETURN (no Button)	LATCHING, SINGLE SOLENOID SPRING RETURN (with Button)	
4-Way 5/2	CSG-4322-316-†-(coil code) 	CGG-4322-316-†-(coil code) 	CAG-4322-316-356BN-†-(coil code) 	CAG-4322-316-356B-†-(coil code) 	
3-Way NC 3/2	CSG-3321-316-†-(coil code) 	CGG-3321-316-†-(coil code) 	CAG-3321-316-356BN-†-(coil code) 	CAG-3321-316-356B-†-(coil code) 	
3-Way NO 3/2	CGS-3322-316-†-(coil code) 	CGG-3321-316-†-(coil code) 	CGA-3322-316-356BN-†-(coil code) 	CGA-3322-316-356B-†-(coil code) 	

† Add suffix option here (see page 25). For coil code (see page 5)

# BODYPORTED VALVES

## Series C-316 Bodyported Dimensions



### Dimensions

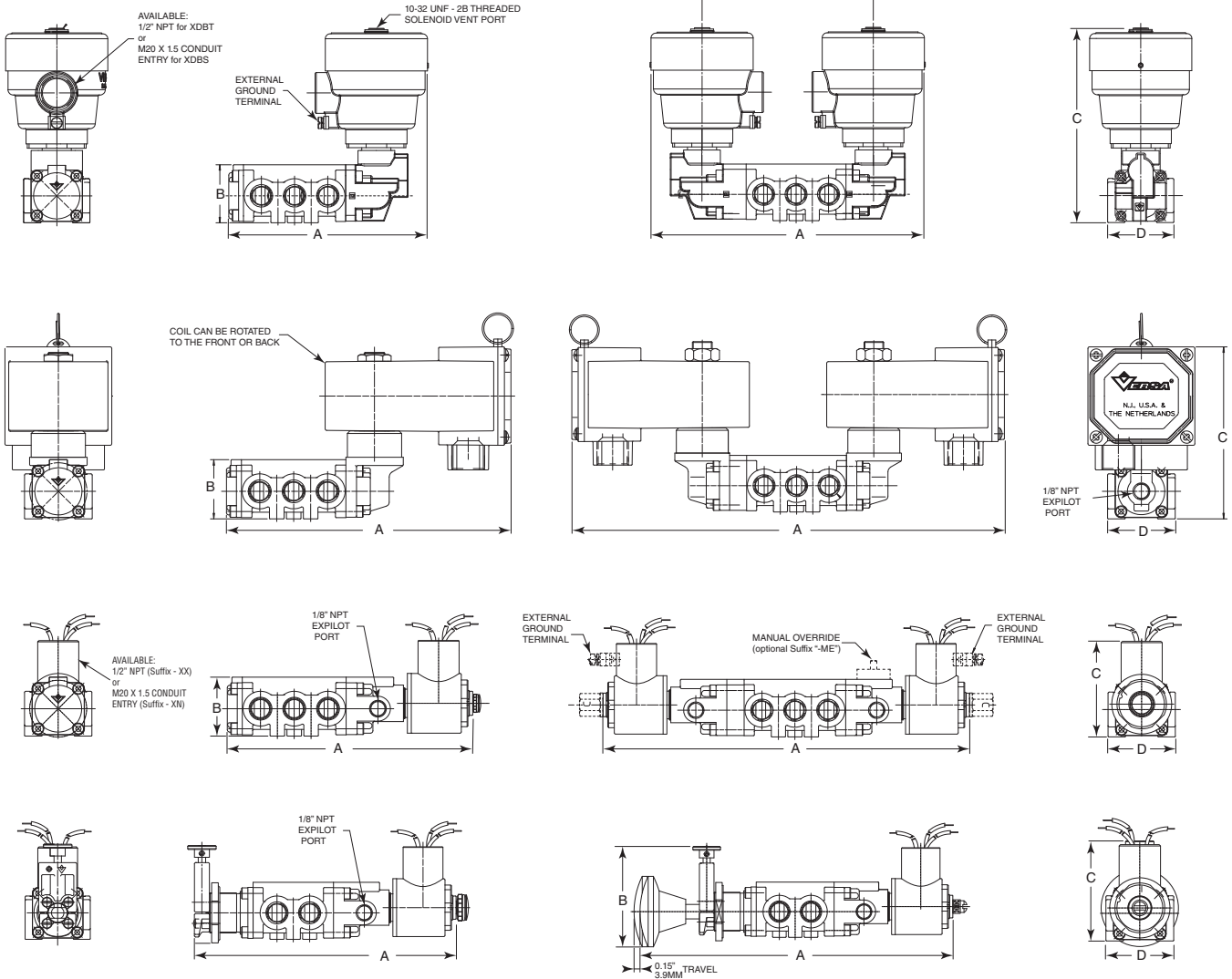

Dimensions		SOLENOID OPTIONS															
		GENERAL SERVICE				HAZARDOUS SERVICE											
						(-XX, -XN, -XISC*, -XISX6*)				(-XMA_, -XIF_)				(XDB_)			
VALVE TYPE		A	B	C	D	A	B	C	D	A	B	C	D	A	B	C	D
3-Way Single Solenoid, Spring Return †	Inches (mm)	5.31 (135.0)	1.42 (36.1)	2.13 (54.2)	1.62 (41.1)	5.41 (137.5)	1.44 (36.6)	2.30 (58.5)	1.62 (41.1)	6.81 (173)	2.56 (65)	4.13 (104.8)	1.62 (41.1)	4.36 (110.7)	1.42 (36.1)	5.1 (130)	1.62 (41.1)
4-Way Single Solenoid, Spring Return †	Inches (mm)	5.81 (147.7)	1.42 (36.1)	2.13 (54.2)	1.62 (41.1)	5.91 (150.2)	1.44 (36.6)	2.30 (58.5)	1.62 (41.1)	6.81 (173)	2.56 (65)	4.13 (104.8)	1.62 (41.1)	4.86 (123)	1.42 (36.1)	5.1 (130)	1.62 (41.1)
3-Way Double Solenoid, Detented †	Inches (mm)	8.33 (211.6)	1.42 (36.1)	2.13 (54.2)	1.62 (41.1)	8.53 (216.8)	1.44 (36.6)	2.30 (58.5)	1.62 (41.1)	10.33 (262.4)	2.56 (65)	4.13 (104.8)	1.62 (41.1)	6.42 (163)	1.42 (36.1)	5.1 (130)	1.62 (41.1)
4-Way Double Solenoid, Detented †	Inches (mm)	8.83 (221.3)	1.42 (36.1)	2.13 (54.2)	1.62 (41.1)	9.03 (229.5)	1.44 (36.6)	2.30 (58.5)	1.62 (41.1)	10.83 (275.0)	2.56 (65)	4.13 (104.8)	1.62 (41.1)	6.92 (175.8)	1.42 (36.1)	5.1 (130)	1.62 (41.1)
3-Way Solenoid, Latching (-356NB)	Inches (mm)	6.41 (162.9)	1.42 (36.1)	2.34 (59.4)	1.62 (41.1)	6.51 (165)	1.44 (36.6)	2.34 (59.4)	1.62 (41.1)	7.41 (188.2)	2.56 (65)	4.13 (104.8)	1.62 (41.1)	5.46 (138.5)	1.42 (36.1)	5.1 (130)	1.62 (41.1)
4-Way Solenoid, Latching (-356NB)	Inches (mm)	6.87 (174.5)	1.42 (36.1)	2.13 (54.2)	1.62 (41.1)	7.0 (177.8)	2.37 (60)	2.34 (59.4)	1.62 (41.1)	7.92 (201.2)	2.56 (65)	4.13 (104.8)	1.62 (41.1)	5.96 (151.4)	1.42 (36.1)	5.1 (130)	1.62 (41.1)
3-Way Solenoid, Latching (-356B)	Inches (mm)	8.9 (226)	1.42 (36.1)	2.13 (54.2)	1.62 (41.1)	8.04 (204)	2.6 (65.7)	2.34 (59.4)	1.62 (41.1)	8.95 (227.3)	2.56 (65)	4.13 (104.8)	1.62 (41.1)	7.0 (177.8)	1.42 (36.1)	5.1 (130)	1.62 (41.1)
4-Way Solenoid, Latching (-356B)	Inches (mm)	9.4 (238.8)	1.42 (36.1)	2.13 (54.2)	1.62 (41.1)	8.54 (216.9)	2.6 (65.7)	2.34 (59.4)	1.62 (41.1)	9.45 (240)	2.56 (65)	4.13 (104.8)	1.62 (41.1)	7.5 (190.5)	1.42 (36.1)	5.1 (130)	1.62 (41.1)

\* For "A" dimension (-XISC, -XISX6) deduct 0.96" (24.4mm). For "C" deduct 0.54" (13.7mm).

† For dimensions -XDA\_ consult factory



# BODYPORTED VALVES

STAINLESS STEEL CONSTRUCTION

## SERIES V-316 Bodyported 3-Way and 4-Way Solenoid Valves

### General Description

Versa Series V-316 valves are available in NPT port sizes 1/4" to 1". Three-way designs are provided with 3 ports; four-way valves 5 ports. 1/4" - 1/2" are available as 2 or 3-position valves. 1" 2-position only.

Investment cast 316L stainless steel bodies and actuating caps, coupled with 316 stainless steel internals makes this valve series compatible for use with aggressive media and environments.

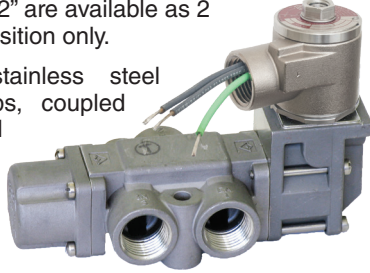

Each valve is solenoid/pilot actuated, which enables the use of physically small solenoids and resultant low power consumption, and also assures a large positive shifting force without fear of coil burnout. A complete selection of electrical connections, area classifications, and power requirements makes the most exacting and demanding specifications or applications easy to satisfy

### Materials

Valve Body:	316L stainless steel
Internal parts (wetted):	316 stainless steel
Actuating Caps:	316 stainless steel
Valve Seals:	FKM (fluorocarbon)
Screws:	stainless steel
Solenoid Parts:	Sleeve, plunger & spring – 304 & 430F stainless steel Coils – epoxy molded with 3 spade terminals (std), or 2 or 3 wire leads (opt). Coil cover (opt.-when applicable) plated steel

### Port Size

Inlet, outlet and exhaust	1/4" NPT
	3/8" NPT
	1/2" NPT
	3/4" NPT
	1" NPT

## Series V-316 Bodyported Valve Product Number Selector

		BASIC VALVE NUMBER				
Function	Port Size (NPT)	Flow Cv	Single Solenoid/Spring Return, 2-Position	Double Solenoid/Momentary Contact 2-Position	Double Solenoid/Spring Centered 3-position	
					Blocked Center	Exhaust Ports Open
3-Way, 3/2 Normally Closed	1/4"	1.8	VSG-3321-316-*	VGG-3321-316-*		_____
	3/8"	2.0	VSG-3421-316-*	VGG-3421-316-*		
	1/2"	5.5	VSG-3521-316-*	VGG-3521-316-*		
	3/4"	9.7	VSG-3621-316-*	VGG-3621-316-*		
	1"	11.1	VSG-3721-316-*	VGG-3721-316-*		
3-Way, 3/3 Three Position	1/4"	1.8			VXX-3323-316-*	_____
	3/8"	2.0			VXX-3423-316-*	_____
	1/2"	5.5			VXX-3523-316-*	_____
3-Way, 3/2 Normally Open	1/4"	1.8	VGS-3322-316-*	SEE ABOVE	_____	_____
	3/8"	2.0	VGS-3422-316-*			
	1/2"	5.5	VGS-3522-316-*			
	3/4"	9.7	VGS-3622-316-*			
	1"	11.1	VGS-3722-316-*			
3-Way, 3/3 Three Position	1/4"	1.8		_____	SEE ABOVE	_____
	3/8"	2.0				
	1/2"	5.5				
4-Way, 5/2 & 5/3	1/4"	1.8	VSG-4322-316-*	VGG-4322-316-*	VXX-4323-316-*	VXX-4324-316-*
	3/8"	2.0	VSG-4422-316-*	VGG-4422-316-*	VXX-4423-316-*	VXX-4424-316-*
	1/2"	5.5	VSG-4522-316-*	VGG-4522-316-*	VXX-4523-316-*	VXX-4524-316-*
	3/4"	9.7	VSG-4622-316-*	VGG-4622-316-*	_____	_____
	1"	11.1	VSG-4722-316-*	VGG-4722-316-*	_____	_____

\* Add coil code to valve number (For coil code see page 5).

Nonhazardous location operators - (page 26) Hazardous Location operators - (Page 26/29)  
For other coil voltages consult factory.

### Operating Pressure

Valve Type	Port Size	Operating Pressure Range <sup>1</sup> (Pneumatic)
Single Solenoid/spring return (2-Position)	1/4", 3/8" & 1/2" NPT	40-175 psi (2.8-12 bar)
	3/4" & 1" NPT	50-175 psi (3.5-12 bar)
Double Solenoid/momentary contact (2-Position)	1/4", 3/8", 1/2", 3/4" & 1" NPT	20-175 psi (1.4-12 bar)
Double Solenoid/spring centered (3-position)	1/4", 3/8" & 1/2" NPT	40-175 psi (2.8-12 bar)

### Installation and Filtration

Valves:	No limitations on mounting orientation.
Filtration:	40 to 50 micron

# BODYPORTED VALVES

## Bodyported Series V-316 Dimensions†



### THREE-WAY

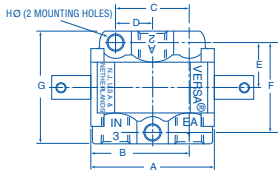

1/4" - 1/2" NPT Body

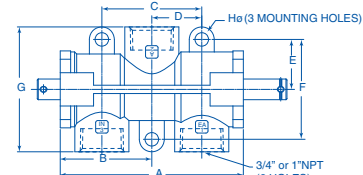

3/4" & 1" NPT Body

#### BODY DETAIL

SIZE NPT	A		B		C		D		E		F		G		H Ø	
	in	mm	in	mm	in	mm	in	mm	in	mm	in	mm	in	mm	in	mm
1/4" - 3/8"	2.19	56	1.75	45	1.31	33	0.66	17	.80	20	1.59	40	2	51	0.27	6.7
1/2"	2.84	95	2.08	52.8	1.31	33	0.66	17	.80	20	1.59	40	2.5	63.5	0.27	6.7
3/4" & 1"	5.5	140	3.25	82.6	3.0	76	1.5	38.1	1.5	40	3.0	6.2	3.38	85.7	0.4	1.2

### SINGLE SOLENOID

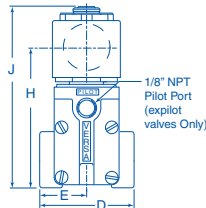
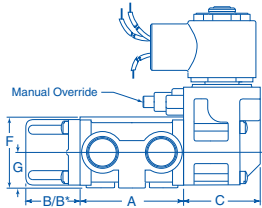

### DOUBLE SOLENOID

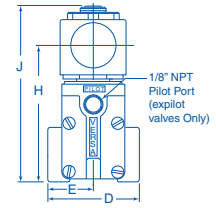
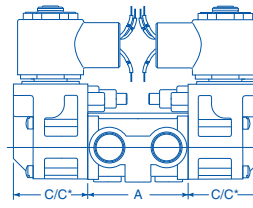

SIZE NPT	A		B		B*		C		C*		D		E		F		G		H		J	
	in	mm	in	mm	in	mm	in	mm	in	mm	in	mm	in	mm	in	mm	in	mm	in	mm	in	mm
1/4" - 3/8"	2.19	55.6	1.15	29.2	1.76	45.1	1.62	41.3	2.54	64.6	2	51	1.0	25.4	3.89	97.4	0.75	19.1	3.83	97.4	2.98	75.7
1/2"	2.84	72.1	1.15	29.2	1.76	45.1	1.62	41.3	2.54	64.6	2.5	63.5	1.25	31.8	3.89	97.4	0.75	19.1	3.83	97.4	2.98	75.7
3/4" & 1"	5.5	139.7	2.01	51	—	—	2.01	51	—	—	3.75	95.3	1.88	47.6	5.17	131.3	4.29	109	5.17	131.3	4.29	109

\*Dimensions for Spring-Centering Valves. NOTE: Adapter is supplied when specified by adding suffix "-H2" to product number.

### FOUR-WAY

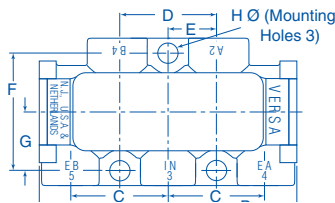

#### BODY DETAIL

SIZE NPT	A		B		C		D		E		F		G	
	in	mm	in	mm	in	mm	in	mm	in	mm	in	mm	in	mm
1/4" - 3/8"	3.5	89	1.75	44.5	1.31	33.3	1.32	33.5	0.66	16.7	1.56	39.6	0.80	20.2
1/2"	4.0	101.6	2.0	51	1.31	33.3	1.32	33.5	0.66	16.7	1.56	39.6	0.80	20.2
1"	8.5	216	4.25	108	3	76.2	3	76.2	1.5	38.1	3.75	95.2	1.88	47.8

### SINGLE SOLENOID

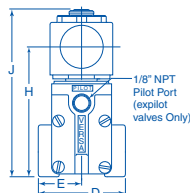
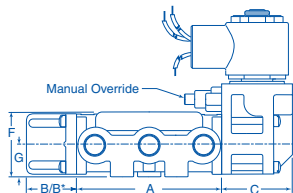

### DOUBLE SOLENOID

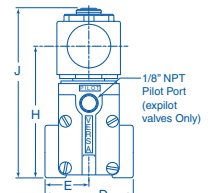
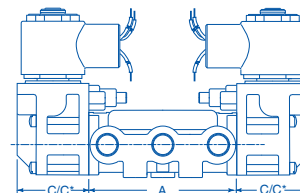

SIZE NPT	A		B		B*		C		C*		D		E		F		G		H		J	
	in	mm	in	mm	in	mm	in	mm	in	mm	in	mm	in	mm	in	mm	in	mm	in	mm	in	mm
1/4" - 3/8"	3.50	88.9	1.15	29.2	1.84	47	1.62	41.3	2.54	64.6	2	51	1.0	25.4	1.56	39.6	0.75	19	2.98	75.7	3.83	97.4
1/2"	4.0	101.6	1.15	29.2	1.84	47	1.62	41.3	2.54	64.6	2.5	63.5	1.25	31.8	1.56	39.6	0.75	19	2.98	75.7	3.83	97.4
3/4" & 1"	8.5	216	2	50.8	—	—	2	50.8	—	—	2.3	58.4	1.16	29.5	2.47	62.7	1.16	29.5	6.9	175.3	5.14	130.5

\*Dimensions for Spring-Centering Valves. NOTE: Adapter is supplied when specified by adding suffix "-H2" to product number.

†Dimensions shown are for basic valve as listed on previous page. Some options may change the dimensions, for which consult factory.

# SPECIAL PURPOSE DUAL SOLENOID VALVES

BRASS OR STAINLESS STEEL CONSTRUCTION

## Push Pull Solenoid Suffix -PPG

### General Description

A dual solenoid valve with a hand lever. The design concept is to provide the functionality of a, dual coil, 2-position valve with the addition of manual control or any other actuator. The valve operates as standard 2-position requiring only momentary electrical contact to shift valve. Various manual actuators are available. The lever shown is a -"L" type which can be manually set in either offset position when the solenoid valve is de-energized.

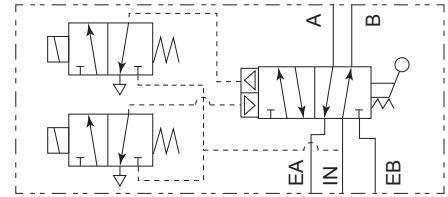
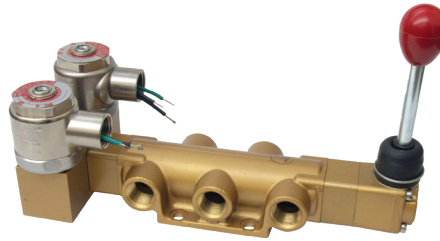

-PPG Flow Schematic

## Redundant Solenoid 2oo2, Suffix -RS

### General Description

When parallel electronic control circuits are utilized in a system, if a complete control circuit fails or requires maintenance, the parallel circuit will keep the system running. In a parallel circuit Versa's Redundant Valve functions the same as a solenoid operated-spring return valve, except that it has two solenoids (one for each of the parallel circuits) rather than one solenoid. Either or both of these solenoids will shift and maintain the controlled device in the shifted position. Both solenoids must be de-energized to return the controlled device to the un-shifted position. The use of one Redundant Valve can replace multiple valves and components to accomplish the same function. This function can be considered as a (2oo2).

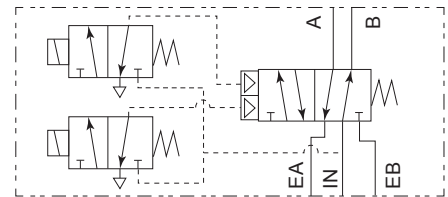
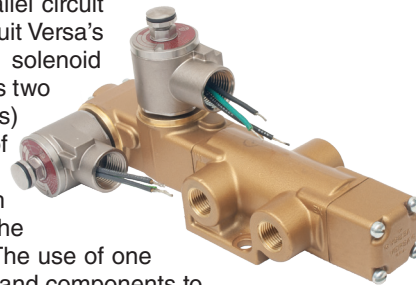

-RS Flow Schematic

## Shut Off Valve 1oo2, Suffix -SOV

### General Description

While the Shut off Valve looks similar to the Redundant Solenoid Valve (shown above) the internal pilot circuit is different. The -SOV option provides a series pilot control circuit that requires both coils, a primary and a secondary, to be energized in order for the valve to shift. Conversely if the electrical signal to either coil is removed the valve will return to the de-energized position. This function can be considered as a (1oo2). Where various control devices (e.g., temperature, pressure switches) could be wired in series with each coil. The actuation of any one of these devices, attached to either coil, would interrupt the signal to the coil and cause the valve to shift to the de-energized position.

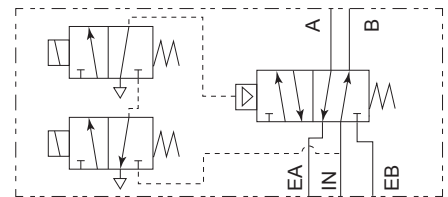

-SOV Flow Schematic

Types Available	SERIES V	SERIES 316
<b>Media:</b>	Pneumatic Service	Pneumatic Service
<b>Pressure:</b>	50 to 175 psi (3.5 to 12 bar)†	40 to 175 psi (2.8 to 12 bar)†
<b>Construction Material:</b>	Forged & machined brass; NBR (nitrile) O-ring seals	Investment cast & machined 316 stainless steel, FKM (fluorocarbon) seals
<b>Functional Types:</b>	3-Way, normally closed 4-Way, 2-Position	3-Way, normally closed 4-Way, 2-Position
<b>Port Sizes &amp; Flow:</b>	1/8" NPT or G1/8 Cv = 1.4 1/4" NPT or G1/4 Cv = 1.8 3/8" NPT or G3/8 Cv = 3.4 1/2" NPT or G1/2 Cv = 4.0	1/4" NPT Cv = 1.8 3/8" NPT Cv = 2.0 1/2" NPT Cv = 5.5
<b>Actuation:</b>	Solenoid/pilot-spring return (2 solenoids per valve), for either ordinary or hazardous service.	Solenoid/pilot-spring return (2 solenoids per valve), for either ordinary or hazardous service.

# SPECIAL PURPOSE DUAL SOLENOID VALVES



## How to specify SPECIAL PURPOSE DUAL SOLENOID VALVES

V = V Series brass or stainless steel. See page 14 for Series V, page 18 for Series V-316.

LA = -PPG with Lever  
IA = -PPG with Button  
AA = -PPG with Latch, see page 22  
SA = -RS -SOV with Spring Return  
AA = -RS -SOV with Latch, see page 22

3 = Three-way  
4 = Four-way

2 = 1/8"NPT (Series V\*\*)  
3 = 1/4"NPT (Series V\*\*) or V-316  
4 = 3/8"NPT (Series V) or V-316  
5 = 1/2"NPT (Series V\*\*) or V-316

2 = Threaded sideports-INPilot solenoid: no auxiliary pilot required.

1 = 3-Way NC  
2 = 3-Way NO, 4-Way/2-Position  
3 = 4-Way/3-Position (blocked center)  
4 = 4-Way/3-Position (exhaust ports open in center)

Add "316" for stainless steel valves. Leave blank for brass valves

SPECIAL PURPOSE DUAL SOLENOID VALVES SUFFIX -RS  
-SOV  
-PPG

OPTIONS (Refer to pages 25 -29 for specific certifications, standards & classifications, approvals, protective codes and voltage codes.)

**V SA - 3 5 2 1 - 316 - RS (OPTIONS)**

\*\* Valves with ISO 228 "G" Threads are designated by utilizing suffix "-2B" in model number.

Installation, Filtration And Lubrication Valves have no limitations on mounting orientation. 40 to 50 micron filtration and general purpose lubricating oil ISO, ASTM viscosity grade 32 recommended. Ambient temperature range -10°F (-23°C) to 200°F (95°C).

## Dimensions

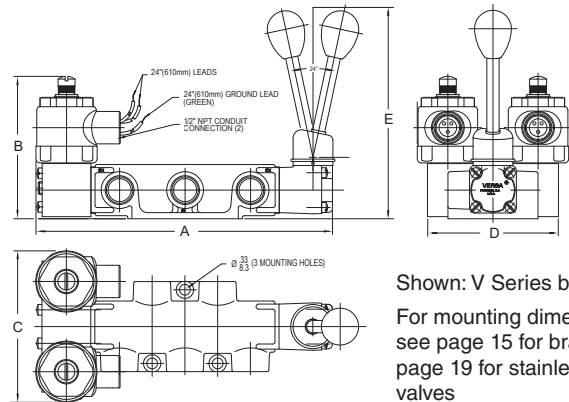
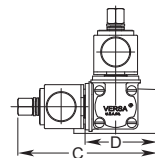
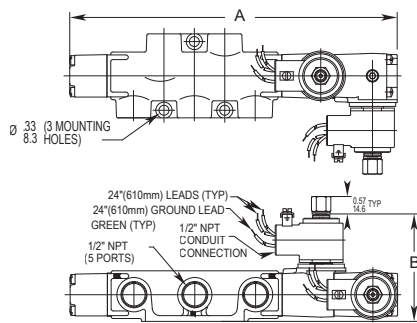

Shown: V Series brass.

For mounting dimensions see page 15 for brass and page 19 for stainless steel valves

		SERIES V						
		SIZE	A	B†	C†	D	E	
R S or S O V	3 W A	1/8 & 1/4 in	7.2	3.45	3.66	2	—	
		mm	183	88	93	51	—	
	4 W A	3/8 & 1/2 in	8.78	3.43	4.18	2.76	—	
		mm	223	87.2	106.1	70	—	
	P P G	3 W A	1/8 & 1/4 in	6.8	4	4.6	2	6.4
			mm	173	103.5	117.5	50.8	161.9
4 W A		3/8 & 1/2 in	7.05	4.35	4.62	2.75	6.45	
		mm	179	110.4	117.4	69.9	163.9	

		SERIES 316						
		SIZE	A	B†	C†	D	E	
R S or S O V	3 W A	1/4 & 3/8 in	7.04	4.04	—	2	—	
		mm	178.8	102.6	—	50.8	—	
	4 W A	1/2 in	6.99	4.4	—	2.5	—	
		mm	178	112	—	63.5	—	
	P P G	3 W A	1/4 & 3/8 in	6.3	3.8	4.63	2	6.32
			mm	161	96.7	117.5	50.8	161
4 W A		1/2 in	6.18	3.74	4.63	2.5	6.32	
		mm	167	95	117.5	63.5	161	

† Dimensions listed are for -XX type hazardous service solenoids. For dimensions with other hazardous service solenoids that can be applied, consult factory.

Dimensions for standard non-hazardous service solenoids will be slightly less than those listed.



# LATCHING/MANUAL RESET VALVES

BRASS OR STAINLESS STEEL CONSTRUCTION

## General Description

Latching valves are particularly suited to applications where it is desirable or mandatory to manually reset or restart a system. A typical application could involve the emergency shutdown of automatically monitored process operations. Loss or interruption of the control signal to the valve actuator causes the valve to shift, latch and shut-down a process step. When the signal is restored the valve remains in the latched position until the operator manually unlatches it and allows the process step to resume. Positive latching in such an application is vitally important since many process operations are sequential and one step must not be started until the one ahead of it has started.

This example is only one of many which can be accommodated through the use of Versa's Latching Valves. A wide range of functional types, port sizes, actuators, and latching arrangements provides the engineer with a complete choice of valving to suit his particular needs.

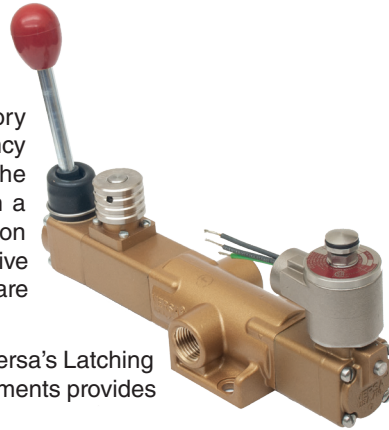

Types Available	Series V	Series V-316
<b>Media</b>	Pneumatic; others, consult factory.	Pneumatic and various other gases, including corrosives.
<b>Pressure: (minimum depends on size and type)</b>	20 or 55 to 175 psi (1.4 or 3.8 to 12 bar)	20 or 55 to 175 psi (1.4 or 3.8 to 12 bar)
<b>Construction Materials</b>	Forged & machined brass; NBR (nitrile) O-ring seals	Investment cast & machined 316 stainless steel; FKM (fluorocarbon) seals
<b>Functional Type</b>	3-Way normally closed 3-Way normally open 3-Way 3-Position 4-Way 2 & 3-Position	3-Way normally closed 3-Way normally open 3-Way 3-Position 4-Way 2 & 3-Position
<b>Body Style</b>	Bodyported	Bodyported
<b>Port Sizes &amp; Flow</b>	1/8" NPT or G1/8 Cv = 1.4 1/4" NPT or G1/4 Cv = 1.8 3/8" NPT or G3/8 Cv = 3.4 1/2" NPT or G1/2 Cv = 4.0 3/4" NPT Cv = 9.7 1" NPT Cv = 11.1	1/4" NPT Cv = 1.8 3/8" NPT Cv = 2.0 1/2" NPT Cv = 5.5 3/4" NPT Cv = 9.7 1" NPT Cv = 11.1
<b>Actuation</b>	Solenoid/pilot for either ordinary service or hazardous service.	Solenoid/pilot for either ordinary service or hazardous service.

## LATCHES IN ACTUATED POSITION

Suffix: V Brass "-181B"  
V-316 "-181BE"

Latches automatically when plunger shifts on signal. Unlatching allows plunger to be returned by hand.

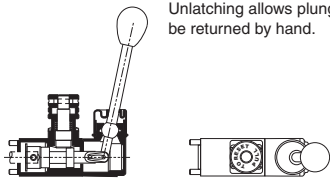

Suffix: V Brass "-181C"  
V-316 "-181CE"

Latches automatically when plunger shifts on signal. Unlatching allows spring to reset plunger automatically. Hand lever provided for manual operation. (If hand lever is not required see suffix -3358A below.)



Suffix: V Brass "-3358A"  
V-316 "-3358AE"

Latches automatically when plunger shifts on signal. Unlatching allows spring to reset plunger automatically. (If hand lever is required for manual actuation see suffix -181C above.)



## Latching/Reset Devices For Series V or V-316 Valves

The Latching Device actuator consists of the latch, with or without an integral spring for returning the valve plunger, and an inline hand operator where needed to manually shift the valve.

The specific Latching Device may be attached to any Series "V" valve body size or style up to 1" NPT or any Series V-316 valve body up to 1/2" NPT, as indicated for the type of latching/reset device required. The actuator on the opposite end of the valve body would be a solenoid/pilot device.

## LATCHES IN UN-ACTUATED POSITION

Suffix: V Brass "-181D"  
V-316 "-181D"

Unlatching allows plunger to shift on signal. If signal is lost, spring shifts plunger automatically and valve latches. When signal is restored, plunger will not shift until manually unlatched. Hand lever is provided for manual operation. (If hand lever is not required see suffix -3358 below.)

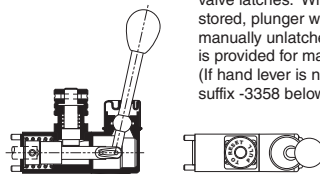

## LATCHES IN EITHER POSITION

Suffix: V Brass "-181AA"  
V-316 "-181AAE"

(2-position latch) Valve may be manually latched in either offset position or left unlatched. Acts as spring return valve when not latched. Hand lever is provided for hand operation.

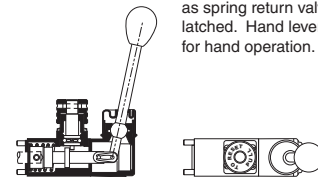

Suffix: V Brass "-3358"  
V-316 "-3358E"

Unlatching allows plunger to shift on signal. Spring returns plunger automatically and valve latches. (If hand lever is required for manual actuation see suffix -181D above.)



# LATCHING/MANUAL RESET VALVES



## How to specify LATCHING/RESET VALVES

V AG - 3 5 2 1 - 181B - (OPTIONS)

V = Pneumatic service: nominal 20 to 175 psi (1.4 - 12 bar); pressure range may vary depending upon specific valve type. See page 14 for Series V, page 18 for Series V-316.

AG=Solenoid/pilot operated for 3-Way NC or 4-Way  
GA=Solenoid/pilot operated for 3-Way NO

3 = Three-way  
4 = Four-way

2 = 1/8"NPT (Series V)\*  
3 = 1/4"NPT (Series V)\* or V-316  
4 = 3/8"NPT (Series V)\* or V-316  
5 = 1/2"NPT (Series V)\* or V-316  
6 = 3/4"NPT (Series V) or V-316  
7 = 1"NPT (Series V) or V-316

2 = Threaded sideports-INPilot solenoid: no auxiliary pilot required.

1 = 3-Way NC  
2 = 3-Way NO, 4-Way/2-Position  
3 = 4-Way/3-Position (blocked center)  
4 = 4-Way/3-Position (exhaust ports open in center)

	Series V	Series V-316
Locking Reset Device	181AA	316-181AAE
	181AB	316-181ABE
(refer to page 22 for specific device required)	181B	316-181BE
	181C	316-181CE
	181D	316-181D
	3358	316-3358E
	3358A	316-3358AE

**OPTIONS:** (Refer to pages 25 -29 for specific certifications, standards & classifications, approvals, protective codes and voltage codes.)

\*Valves with ISO 228 "G" Threads are designated by adding suffix "-2B" in model number.

Shown V Series brass  
For mounting dimensions see page 15 for brass and page 19 for stainless steel valves

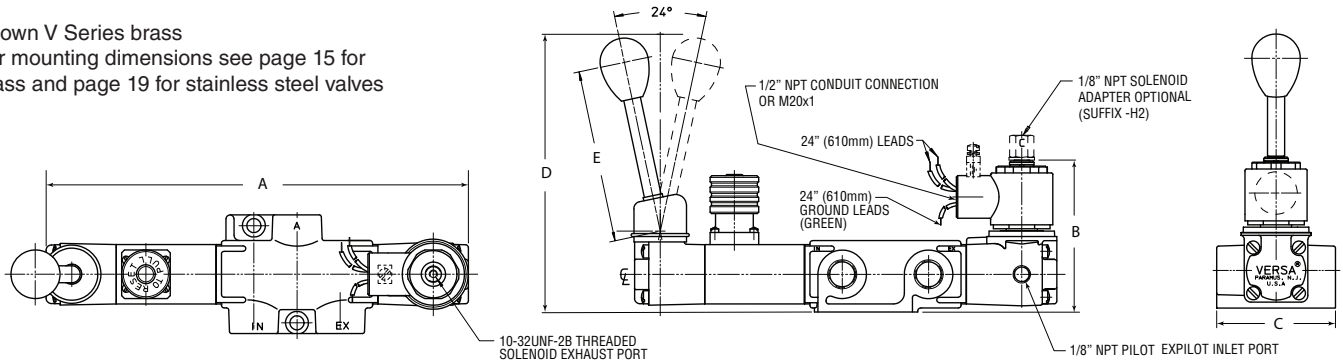

		Series V					
		SIZE	A	B	C	D	E
3 W A Y	1/8 & 1/4	in	8.2	3.44	2	6.37	4
		mm	209	87.5	50.8	162	101.6
	3/8 & 1/2	in	9.8	3.46	2.75	6.4	4
		mm	248.4	87.8	69.9	163.5	101.6
3/4 & 1	in	12.1	4.86	3.75	8.06	9.4	
	mm	307.3	123.5	95.2	204.6	239.5	
4 W A Y	1/8 & 1/4	in	9.53	3.44	2	6.37	4
		mm	242	87.5	50.8	162	101.6
	3/8 & 1/2	in	11.8	3.46	2.75	6.4	4
		mm	299	87.8	69.9	163.5	101.6
3/4 & 1	in	15.1	4.86	3.75	8.06	9.4	
	mm	426	123.5	95.2	204.6	239.5	

		Series V-316					
		SIZE	A	B†	C†	D	E
3 W A Y	1/4" & 3/8"	in	77.8	3.83	2	6.3	4
		mm	197.6	97.4	50.8	160.4	101.6
	1/2"	in	77.8	3.83	2.5	6.3	4
		mm	197.6	97.4	63.5	160.4	101.6
3/4" & 1"	in	13.5	5.14	3.75	8.8	4	
	mm	344	131	95.3	222	101.6	
4 W A Y	1/4" & 3/8"	in	9.09	3.83	2	6.3	4
		mm	231	97.4	50.8	160.4	101.6
	1/2"	in	9.6	3.83	2.5	6.3	4
		mm	243.7	97.4	63.5	160.4	101.6
3/4" & 1"	in	8.5	5.14	3.75	8.8	4	
	mm	215.9	131	95.3	222	101.6	

# LOCKOUT VALVES

BRASS OR STAINLESS STEEL CONSTRUCTION

## 3-Way NC Solenoid Operated/Spring Return Lockout Valves

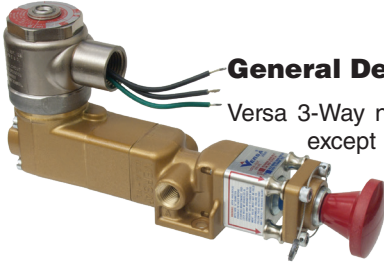

### General Description

Versa 3-Way normally closed Lockout Valves function the same as a solenoid operated-spring return valve, except that a means is provided to allow the valve to be physically locked with a padlock or hasp with padlock in order to prevent accidental actuation. Two types of lockouts are available: one provides the ability for locking the valve in the de-energized position whereby the inlet is blocked and the exhaust is open; the other type provides the ability for locking in either the de-energized or energized position.

### Types Available

	Series V	Series V-316
<b>Media:</b>	Pneumatic Service	Pneumatic Service
<b>Pressure:</b> (minimum depends on valve size)	40 or 50 to 175 psi (2.8 or 3.5 - 12 bar)	40 to 175 psi (2.8 - 12 bar)
<b>Construction Materials:</b>	Forged & machined brass; NBR (nitrile) O-ring seals	Investment cast & machined 316 stainless steel; FKM (fluorocarbon) seals
<b>Functional Type:</b>	3-Way normally closed	3-Way normally closed
<b>Body Style:</b>	Bodyported	Bodyported
<b>Port Sizes &amp; Flow:</b>	1/8"NPT or G1/8 $C_v = 1.4$ 1/4"NPT or G1/4 $C_v = 1.8$ 3/8"NPT or G3/8 $C_v = 3.4$ 1/2"NPT or G1/2 $C_v = 4.0$ 3/4"NPT $C_v = 9.7$ 1"NPT $C_v = 11.1$	1/4"NPT $C_v = 1.8$ 3/8"NPT $C_v = 2.0$ 1/2"NPT $C_v = 5.5$
<b>Actuation:</b>	Solenoid/pilot-spring return for either Ordinary Service or Hazardous Service	Solenoid/pilot-spring return for either Ordinary Service or Hazardous Service.

## Lockout Valves Product Number Selector

		Series V		Series V-316			
FUNCTION	PORT SIZE	FLOW $C_v$	LOCKOUT IN EXHAUST POSITION	LOCKOUT IN EITHER POSITION	LOCKOUT IN EXHAUST POSITION	LOCKOUT IN EITHER POSITION	OPERATING PRESSURE
3-Way NC	1/8" NPT**	1.4	VIA-3221-138-LOVB-*	VIA-3221-138-LOVE-*	—	—	40-175 psi (2.8-12 bar)
	1/4" NPT**	1.8	VIA-3321-138-LOVB-*	VIA-3321-138-LOVE-*	—	—	
	1/4" NPT	1.8	—	—	VIA-3321-316-138E-LOVBEE-*	VIA-3321-316-138E-LOVEE-*	
	3/8" NPT**	3.4	VIA-3421-138-LOVB-*	VIA-3421-138-LOVE-*	—	—	
	3/8" NPT	2.0	—	—	VIA-3421-316-138E-LOVBEE-*	VIA-3421-316-138E-LOVEE-*	
	1/2" NPT**	4.0	VIA-3521-138-LOVB-*	VIA-3521-138-LOVE-*	—	—	
	1/2" NPT	5.5	—	—	VIA-3521-316-138E-LOVBEE-*	VIA-3521-316-138E-LOVEE-*	
	3/4" NPT	9.7	VIA-3621-138-LOVB-*	VIA-3621-138-LOVE-*	—	—	50-175 psi (3.5-12 bar)
1" NPT	11.1	VIA-3721-138-LOVB-*	VIA-3721-138-LOVE-*	—	—		

\* Add coil code to valve number (see page 5).

\*\* Valves with ISO 228 "G" threads are designated by utilizing Suffix -2B in model number.

### Options

Options:  
For solenoid options see pages 25 - 29  
For miscellaneous options see page 29

### Installation, Filtration and Lubrication

Valves have no limitations on mounting orientation.  
40 to 50 micron filtration and general purpose lubricating oil  
ISO, ASTM viscosity grade 32 recommended.

## Combination Suffix Details Electrical Operators Hazardous Location Cross Reference Chart

Suffix Reference	
Suffix	Description
-CD	72" wire leads
-D14	Solenoid vent, water proof nut
-H2E	1/8" npt Solenoid vent
-HE	1/4" npt Solenoid vent
-HT	Class H coil
-L14	Solenoid vent dust nut
-LA	0.85 watt Solenoid
-LB	1.8 watt Solenoid
-LV	0.85 watt (World Solenoid)
-LX	1.8 watt (World Solenoid)
-LZ	0.5 watt (World Solenoid)
-PC	Potted coil, NEMA 4
-PS	Potted coil, male conduit;
-ST	Stainless Solenoid housing
-XDBS	World Solenoid**
-XDBT	World Solenoid**
-VJBT	Add on Junction Box
-XN	ATEX Solenoid
-XT	World Solenoid**
-XV	World Solenoid, North America
-XX	North American Solenoid
-303D	Integral diode

North American (-XX) (Cont.)	
Combination Suffix	Included Suffix
-XXK	-XX, -HT, -LB, -PC, -ST
-XXK4	-XX, -D14, -HT, -LB, -PC, -ST
-XXL	-XX, -PC
-XXL4	-XX, -D14, -PC
-XXM	-XX, -HT, -PC
-XXM4	-XX, -D14, -HT, -PC
-XXN	-XX, -LB, -PC
-XXN4	-XX, -D14, -LB, -PC
-XXP	-XX, -HT, -LB, -PC
-XXP4	-XX, -D14, -HT, -LB, -PC
-XXQ	-XX, -HT, -LB
-XXQ4	-XX, -D14, -HT, -LB
-XXR	-XX, -LB
-XXR4	-XX, -D14, -LB
-XXS	-XX, -LA, -ST
-XXS4	-XX, -D14, -LA, -ST
-XXU	-XX, -HT, -LB, -ST
-XXU4	-XX, -D14, -HT, -LB, -ST
-XXV	-XX, -LA
-XXV4	-XX, -D14, -LA
-XXW	-XX, -CD, -HT, -H2, -PC, -ST
-XXW4	-XX, -D14, -CD, -HT, -PC, -ST

ATEX (-XN) (Cont.)	
Combination Suffix	Included Suffix
-XNQ	-XN, -HT, -LB
-XNR	-XN, -LB
-XNS	-XN, -LA, -ST
-XNU	-XN, -HT, -LB, -ST
-XNV	-XN, -LA
-XNX	-XN, -LB, -PS
-XNWS	-XN, -VJBT, -LB, -PS

North American (-XX)	
Combination Suffix	Included Suffix
-XXA	-XX, -HT
-XXA4	-XX, -D14, -HT
-XXB	-XX, -PS
-XXB4	-XX, -D14, -PS
-XXC	-XX, -HT, -PS
-XXC4	-XX, -D14, -HT, -PS
-XXD	-XX, -ST
-XXD4	-XX, -D14, -ST
-XXE	-XX, -PC, -ST
-XXE4	-XX, -D14, -PC, -ST
-XXF	-XX, -HT, -ST
-XXF4	-XX, -D14, -HT, -ST
-XXG	-XX, -LB, -ST
-XXG4	-XX, -D14, -LB, -ST
-XXH	-XX, -HT, -PC, -ST
-XXH4	-XX, -D14, -HT, -PC, -ST
-XXJ	-XX, -LB, -PC, -ST
-XXJ4	-XX, -D14, -LB, -PC, -ST

ATEX (-XN)	
Combination Suffix	Included Suffix
-XNA	-XN, -HT
-XND	-XN, -ST
-XNE	-XN, -PC, -ST
-XNE4	-XN, D14, -PC, -ST
-XNF	-XN, -HT, -ST
-XNG	-XN, -LB, -ST
-XNH	-XN, -HT, -PC, -ST
-XNJ	-XN, -LB, -PC, -ST
-XNJ4	-XN, -D14, -LB, -PC, -ST
-XNK	-XN, -HT, -LB, -PC, -ST
-XNL	-XN, -PC
-XNL4	-XN, -D14, -PC
-XNM	-XN, -HT, -PC
-XNN	-XN, -LB, -PC
-XNN4	-XN, -D14, -LB, -PC
-XNP	-XN, -HT, -LB, -PC

World Solenoid (-XDB, -XT, -XV)			
Combination Suffix		Included Suffix	
1.8 Watt	0.85 Watt	1.8 Watt	0.85 Watt
-XDBS1	-XDBS1C	-XDBS, -HT, -LX	-XDBS, -HT, -LX
-XDBS2	-XDBS2C	-XDBS, -HT, -LX, -H2E	-XDBS, -HT, -LX, -H2E
-XDBS3	-XDBS3C	-XDBS, -HT, -LX, -HE	-XDBS, -HT, -LX, -HE
-XDBS4	-XDBS4C	-XDBS, -HT, -LX, -L14	-XDBS, -HT, -LX, -L14
-XDBS5	-XDBS5C	-XDBS, -HT, -LX, -303D	-XDBS, -HT, -LX, -303D
-XDBS6	-XDBS6C	-XDBS, -HT, -LX, -H2E, -303D	-XDBS, -HT, -LX, -H2E, -303D
-XDBS7	-XDBS7C	-XDBS, -HT, -LX, -HE, -303D	-XDBS, -HT, -LX, -HE, -303D
-XDBS8	-XDBS8C	-XDBS, -HT, -LX, -L14, -303D	-XDBS, -HT, -LX, -L14, -303D
-XDBS9	-XDBS9C	-XDBS, -HT, -LX, -D14	-XDBS, -HT, -LX, -D14
-XDBS10	-XDBS10C	-XDBS, -HT, -LX, -D14, -303D	-XDBS, -HT, -LX, -D14, -303D
-XDBT1	-XDBT1C	-XDBT, -HT, -LX	-XDBT, -HT, -LX
-XDBT2	-XDBT2C	-XDBT, -HT, -LX, -H2E	-XDBT, -HT, -LX, -H2E
-XDBT3	-XDBT3C	-XDBT, -HT, -LX, -HE	-XDBT, -HT, -LX, -HE
-XDBT4	-XDBT4C	-XDBT, -HT, -LX, -L14	-XDBT, -HT, -LX, -L14
-XDBT5	-XDBT5C	-XDBT, -HT, -LX, -303D	-XDBT, -HT, -LX, -303D
-XDBT6	-XDBT6C	-XDBT, -HT, -LX, -H2E, -303D	-XDBT, -HT, -LX, -H2E, -303D
-XDBT7	-XDBT7C	-XDBT, -HT, -LX, -HE, -303D	-XDBT, -HT, -LX, -HE, -303D
-XDBT8	-XDBT8C	-XDBT, -HT, -LX, -L14, -303D	-XDBT, -HT, -LX, -L14, -303D
-XDBT9	-XDBT9C	-XDBT, -HT, -LX, -D14	-XDBT, -HT, -LX, -D14
-XDBT10	-XDBT10C	-XDBT, -HT, -LX, -D14, -303D	-XDBT, -HT, -LX, -D14, -303D
-XV1	-XV1C	-XV, -HT, -LX	-XV, -HT, -LX
-XV2	-XV2C	-XV, -HT, -LX, -H2E	-XV, -HT, -LX, -H2E
-XV3	-XV3C	-XV, -HT, -LX, -HE	-XV, -HT, -LX, -HE
-XV4	-XV4C	-XV, -HT, -LX, -L14	-XV, -HT, -LX, -L14
-XV9	-XV9C	-XV, -HT, -LX, -D14	-XV, -HT, -LX, -D14
-XT1	-XT1C	-XT, -HT, -LX	-XT, -HT, -LX
-XT2	-XT2C	-XT, -HT, -LX, -H2E	-XT, -HT, -LX, -H2E
-XT3	-XT3C	-XT, -HT, -LX, -HE	-XT, -HT, -LX, -HE
-XT4	-XT4C	-XT, -HT, -LX, -L14	-XT, -HT, -LX, -L14
-XT9	-XT9C	-XT, -HT, -LX, -D14	-XT, -HT, -LX, -D14

### Recommended Hazardous Location Solenoid Option Packages

Series	Enclosure/Wire	Certification/Power			
		North American - CSA		ATEX - IECEx - INMETRO	
		Standard Power	Low Watt*	Standard Power	Low Watt*
ESM, V	Steel, Electroless Nickel Plated, 24 Inch Leads	-XXL4	—	—	—
C, C316 E5, E5QE, NAMUR, V, V316	Steel, Electroless Nickel Plated, 24 Inch Leads	-XXL4	-XXN4	-XNL4	-XNN4
C, C316, E4, E4QE, NAMUR, V, V316	Stainless Steel, High Performance 430 type, 24" wire leads	—	-XV9	—	-XT9**
	Stainless Steel, 316L type, Junction Box with Terminal Strip	—	-XDBT9**	—	-XDBS9**



\*1.8 watt solenoid. Also available 0.85 watt, see cross reference chart above, 1.8 & 0.85 not available on E. For 0.50 watt, consult factory.

\*\*All the -XDBS, -XDBT & -XT solenoids are "World Solenoids" certified for North America, ATEX, IECEx and INMETRO. For additional certifications consult factory. -XV solenoids certified for North America. See page 29 for additional options.













For option package recommendations see page 29.



# ELECTRICAL OPERATOR SPECIFICATIONS

General Purpose	Series	Suffix Identification	Protection Classification	Area Classification and (Gas Grouping)	Certification-(Conformance)	Ingress Protection
	V ESM	None or -U	General Purpose	Indoor & Outdoor	CSA, UL	NEMA 1,2,3, 4, IP65
	C, C316 E5 E5QE	None or -U			CSA	NEMA 1,2,3
	NAMUR V316	-HC -HCC (Shown)			CSA, UL	NEMA 4; IP65

## Hazardous Location Solenoids

				Agency Approvals						
				North America		World*				
				SP		Ex IEC IECEx				
Series	Suffix*	Protection Classification	Zones	Divisions	Area Classification and (Gas Grouping)	Agency	Ingress Protection			
	ESM V	-XX	Hazardous Locations	—	CL I, DIV 1, Grp (C & D) CL II, DIV 1, Grp (E, F & G) Temp T3C	UL CSA	NEMA 7 & 9			
	C C316 E5 E5QE, NAMUR V V316	-XX			CL I, DIV 2 Grp (A B C) CL II, DIV 2 Grp (E, F & G) Temp T3C					
	C C316 E4 E4QE, NAMUR V V316	-XN	(d) Flameproof	—	Ex d IIB+H2 T3...T6 Gb II 2 G Ex d IIB+H2 T3...T6 Gb	IECEX ATEX	IP66/67			
	C C316 E5 E5QE, NAMUR V V316	-XV	Hazardous Locations	—	—	cCSA <sub>US</sub>	NEMA 4, 4X, 6P, IP66			
		-XT	(d) Flameproof	CL, I, Zn 1 A/Ex de IIC T CL, II Zn, 21 AEx tD A21, DIP A21	CL I, DIV 1, Grp (B, C, D) CL II, DIV1, Grp (E, F, G) CL III CL I, DIV 2, Grp (A, B, C, D) CL II, DIV 1, Grp (E, F, G) CL III			ATEX, IECEX, INMETRO		
		-XDBT	(d) Flameproof (e) Increased Safety		—				Ex II 2 G D A/Ex d e IIC T3...T6 Gb Ex tb IIIC T3...T6 Db	IP66/67/68
		-XDBS	(d) Flameproof (t) Enclosure, dust							
	DSM	-XDDS	(d) Flameproof (t) Enclosure, dust		—	Ex II 2 G D Ex d IIC T4 Gb Ex tb IIIC IP66 T4 °C Db	cCSA <sub>US</sub>			
	C C316 E5 E5QE, NAMUR V V316	-XMAA -XMAF	(mb) Encapsulation	—	Ex e mb IIC T5, T6 Gb Ex tb IIIC T85°C, T100°C Db	IECEX TR CU ATEX	IP67			
		-XMFA -XMFF	(e) Increased Safety					II 2 G Ex e mb IIC T5...T6 Gb II 2 D Ex tb IIIC T85°C...T100°C Db		
	C C316 E5 E5QE, NAMUR V V316	-XIFA -XIFF	(ia) Intrinsic Safe	—	Ex (ia) IIC T4...T6 Gb Ex (ia) IIIC T130°C...T80°C Db	IECEX TR CU ATEX	IP67			
		-HC -XISX6	Intrinsic Safe	—	CL I, DIV 1, Grp (A, B, C & D) CL II, DIV 1, Grp (E, F, & G) CL III	II 2 G Ex ia IIC T4...T6 Gb II 2 G Ex ia IIB T4...T6 Gb	ATEX IECEX TR CU CSA FM	IP65		
		-HCC -XISX6		—	—	—	—			

# ELECTRICAL OPERATOR SPECIFICATIONS

	Voltage (Power)	Electrical Characteristics	Miscellaneous																																						
	AC: 24V60, 120V60, 240V60 (7.3W) 24V50, 110V50, 220V50 (7.3W) DC: 12VDC, 24VDC, 48VDC (9.5W)	Class F epoxy molded coil (155°C). Continuous duty, 2 leads 24" (60 cm).	Steel cover with 1/2 NPT conduit entry.																																						
	All usual 50 Hz & 60 Hz AC (7.3W) All usual DC (9.5W)																																								
	AC: 24V60, 120V60, 240V60 (8.5W) 24V50, 110V50, 220V50 (8.5W) DC: 12VDC, 24VDC, 48VDC (10.5W)	Class F epoxy molded coil (155°C), continuous duty.	Coil connection 3 spade terminals with mini DIN socket available with PG9 cable gland(-HC) or 1/2" NPT conduit hub (-HCC).																																						
	Voltage (Power)	Electrical Characteristics	Miscellaneous																																						
	50 Hz & 60 Hz AC (7.3W), DC (9.5W) AC: 12V60, 24V60, 48V60, 120V60, 240V60 DC: 6VDC, 12VDC, 24VDC, 48VDC	Class F epoxy molded coil (155°C). continuous duty. 3 leads 24" (60 cm).	Plated steel coil housing with 1/2 NPT conduit entry. For additional solenoid options see pages 25																																						
	50 Hz & 60 Hz AC (6W), DC (7.2W) & (1.8W) AC: 12V60 (A012), 24V60 (A024), 48V60 (A048), 120V60 (A120), 240V60 (A120) DC: 6VDC (D006), 12VDC (D012), 24VDC (D024), 48VDC (D048)		Plated steel coil housing with 1/2 NPT conduit entry. For additional solenoid options see pages 5																																						
			Plated steel coil housing with M20 x 1.5 conduit entry. Ground terminal on cover. For additional solenoid options see pages 25																																						
	AC: 120V60HZ (A120), 240V60HZ (A240) 110V50HZ (E110), 220V50HZ (E230) DC: 12VDC (D012), 24VDC (D024) 48VDC (D048), 120VDC (D120)  1.8 watt standard. For 0.85 watt consult factory.	Epoxy molded coils rated for continuous duty, Class H (180°C).	<table border="1"> <thead> <tr> <th rowspan="2">Stainless steel coil housing with 1/2" NPT conduit connection.</th> <th colspan="2">Suffix Detail Ordering Code</th> </tr> <tr> <th>XV</th> <th>XT</th> </tr> </thead> <tbody> <tr> <td></td> <td colspan="2">1.8 watt</td> </tr> <tr> <td>Standard (vent to atmosphere)</td> <td>-XV1</td> <td>-XT1</td> </tr> <tr> <td>1/8" Adapter (-H2E)</td> <td>-XV2</td> <td>-XT2</td> </tr> <tr> <td>1/4" Adapter (-HE)</td> <td>-XV3</td> <td>-XT3</td> </tr> <tr> <td>Dust Nut (-L14)</td> <td>-XV4</td> <td>-XT4</td> </tr> <tr> <td>Water proof nut (-D14)</td> <td><b>-XV9*</b></td> <td><b>-XT9*</b></td> </tr> </tbody> </table>	Stainless steel coil housing with 1/2" NPT conduit connection.	Suffix Detail Ordering Code		XV	XT		1.8 watt		Standard (vent to atmosphere)	-XV1	-XT1	1/8" Adapter (-H2E)	-XV2	-XT2	1/4" Adapter (-HE)	-XV3	-XT3	Dust Nut (-L14)	-XV4	-XT4	Water proof nut (-D14)	<b>-XV9*</b>	<b>-XT9*</b>															
Stainless steel coil housing with 1/2" NPT conduit connection.	Suffix Detail Ordering Code																																								
	XV		XT																																						
	1.8 watt																																								
Standard (vent to atmosphere)	-XV1	-XT1																																							
1/8" Adapter (-H2E)	-XV2	-XT2																																							
1/4" Adapter (-HE)	-XV3	-XT3																																							
Dust Nut (-L14)	-XV4	-XT4																																							
Water proof nut (-D14)	<b>-XV9*</b>	<b>-XT9*</b>																																							
		<table border="1"> <thead> <tr> <th rowspan="2">Stainless steel coil housing with internal Junction Box. Internal and external ground screw.</th> <th colspan="4">Suffix Detail Ordering Code</th> </tr> <tr> <th colspan="2">M 20 Connection</th> <th colspan="2">1/2" Connection</th> </tr> <tr> <td></td> <th>No Diode</th> <th>Diode</th> <th>No Diode</th> <th>Diode</th> </tr> </thead> <tbody> <tr> <td>Standard (vent to atmosphere)</td> <td>XDBS1</td> <td>XDBS5</td> <td>XDBT1</td> <td>XDBT5</td> </tr> <tr> <td>1/8" Adapter (-H2E)</td> <td>XDBS2</td> <td>XDBS6</td> <td>XDBT2</td> <td>XDBT6</td> </tr> <tr> <td>1/4" Adapter (-HE)</td> <td>XDBS3</td> <td>XDBS7</td> <td>XDBT3</td> <td>XDBT7</td> </tr> <tr> <td>Dust Nut (-L14)</td> <td>XDBS4</td> <td>XDBS8</td> <td>XDBT4</td> <td>XDBT8</td> </tr> <tr> <td>Dust Excluder (-D14)</td> <td><b>XDBS9*</b></td> <td><b>XDBS10</b></td> <td><b>XDBT9*</b></td> <td><b>XDBT10*</b></td> </tr> </tbody> </table>	Stainless steel coil housing with internal Junction Box. Internal and external ground screw.	Suffix Detail Ordering Code				M 20 Connection		1/2" Connection			No Diode	Diode	No Diode	Diode	Standard (vent to atmosphere)	XDBS1	XDBS5	XDBT1	XDBT5	1/8" Adapter (-H2E)	XDBS2	XDBS6	XDBT2	XDBT6	1/4" Adapter (-HE)	XDBS3	XDBS7	XDBT3	XDBT7	Dust Nut (-L14)	XDBS4	XDBS8	XDBT4	XDBT8	Dust Excluder (-D14)	<b>XDBS9*</b>	<b>XDBS10</b>	<b>XDBT9*</b>	<b>XDBT10*</b>
Stainless steel coil housing with internal Junction Box. Internal and external ground screw.	Suffix Detail Ordering Code																																								
	M 20 Connection		1/2" Connection																																						
	No Diode	Diode	No Diode	Diode																																					
Standard (vent to atmosphere)	XDBS1	XDBS5	XDBT1	XDBT5																																					
1/8" Adapter (-H2E)	XDBS2	XDBS6	XDBT2	XDBT6																																					
1/4" Adapter (-HE)	XDBS3	XDBS7	XDBT3	XDBT7																																					
Dust Nut (-L14)	XDBS4	XDBS8	XDBT4	XDBT8																																					
Dust Excluder (-D14)	<b>XDBS9*</b>	<b>XDBS10</b>	<b>XDBT9*</b>	<b>XDBT10*</b>																																					
	AC: 120V60HZ (A120) 240V60HZ (A240), 110V50HZ (E110) 230V50HZ (E230) DC: 12VDC (D012), 24VDC (D024), 125VDC (D125)  (2.6 w)		316L stainless steel coil housing with internal Junction Box. Internal and external ground screw. M20 conduit hub  316L stainless steel coil housing with internal Junction Box. Internal and external ground screw. 1/2" NPT conduit hub																																						
	24VDC (4W) (Consult factory for other voltage options)	Continuous duty coil & rectifier, including surge suppression, potted within housing.	Thick wall epoxy coil housing with integral junction box. Internal ground terminal. M20 x 1.5 conduit entry: (-XMAA), (-XMFA), 1/2 NPT conduit entry with adapter: (-XMAF), (-XMFF)																																						
	24VDC 10W inrush, 2.6W holding) (Consult factory for other voltages)	Continuous duty coil & power controller potted within housing.																																							
	24VDC (0.8W) (Consult factory for other voltages)																																								
	24VDC (1.6 watt max.) System voltage prior to barrier	Class F epoxy molded coil (155°C). Continuous duty.	Requires the use of an approved barrier or isolator. Maximum operating system voltage before barrier 28VDC. Maximum pilot pressure 115 psi (8 bar). 3 spade terminals, ISO DIN 43650, Form "A" PG9 cable gland (-HC) 1/2 NPT conduit entry: (-HCC)																																						







\*Bold, recommended solenoid options.  
See page 25 for additional options.

# ELECTRICAL OPERATOR SPECIFICATIONS

## Solenoid Options Availability Chart

### Nonhazardous Location

### VALVE SERIES

Option Code	NAMUR		NAMUR C-316	C5/C7 C9	E4	E5	D	V	C-316	V-316	
	C5	E5	C-316	C9							
 1/2" NPT Conduit entry, NEMA 1,2,3	-C50	X	X	Standard	X	Standard	Standard	—	Standard	Standard	Standard
 1/2" NPT Conduit entry, Potted coil NEMA 4 & 4X, 11, 12, 13.	-PC	X	X	X	X	X	X	—	X	X	-X
 1/2" NPT Conduit Integrally Molded Coil & Conduit Entry, NEMA 4/IP65.	-228L	X	X	—	X	—	—	—	—	—	—
 3 Spade Terminals, for use with mini DIN connector	Standard	X	X	—	X	—	—	—	—	—	—
 Mini DIN Connector with PG9 cord grip, NEMA 4.	-HC	X	X	X	X	X	X	—	X	X	X
 Mini DIN Connector with 1/2" NPT conduit entry, NEMA 4.	-HCC	X	X	X	X	X	X	—	X	X	X

### Hazardous Location

### VALVES SERIES

Option Code	NAMUR		NAMUR C-316†	C5/C7 C9	E4**	E5	D	V	C-316†	V-316
	C5	E5	C-316†	C9						
 CSA UL CLASS I, DIV. 1 (C & D) CLASS I, DIV. 2 (A & B) CLASS II, DIV. 1 (E, F & G) ATEX, IECEx Ex d IIB+H2 T3 to T6 Gb II 2 G Ex d IIB+H2 T3 to T6					—	Available. See page 29.	—			
 ATEX, IECEx, CSA: EX II 2 G D Ex de IIC T* Gb EX tb IIIC T* °C Db EX de IIC DIP A21 T6 T4 CI I, Zone 1 Ex de IIC T* CI II, Zone 21 AEx tD, DIP 21			Available. (see page 29 for recommended options).			—	—	Available. (see page 29 for recommended options).		
 ATEX, IECEx, CSA: EX II 2 G D Ex d e IIC T* Gb EX tb IIIC T* °C Db EXd IIC DIP A21 T6 T4 CI Grp B, C & D; CII Grp E, F & G, CIII CI I, Zone 1 Ex de IIC T* CI II, Zone 21 AEx tD, DIP A21										
 ATEX IECEx CSA: Ex II 2 G D Ex de IIC T4 Gb Ex tb IIIC IP66 T* °C Db CI, I Zn 1, A/Ex de IIC CI, II, Zn 21, AEx tD A21, T* °C							-XDDS*			
 ATEX IECEx, CSA: Ex II 2 G D Ex d IIC T4 Gb Ex tb IIIC IP66 T4 °C Db Ex d IIC T4, CI I, Zn 1, AEx d IIC T4 Zone 21, AEx tb IIIC T4 Db CI I Div 1, Grps B, C & D CI II Div 1 Grps E, F & G, CI III T4 CI I Div 2, Grps A, B, C & D T4							-XDDT**			
 (e) Increased Safety (m) Encapsulated (tD) Dust Tight IECEx: Ex e Ex mb, Ex tD Ex e mb II T5, T6 Gb Ex tD A21 T100°C, 85°C ATEX: EEx II 2 G Ex e mb II T5, T6 Ex tD A21 T100°C, 85°C			-XMAA		-XMAA			-XMAE	-XMAA	-XMAA
(ia) Intrinsic Safe ATEX: EEx II 2 G EEx ia IIC T4, T5			-XIFA		-XIFA			-XIFA	-XIFA	-XIFA
Factory Mutual & CSA Class I, Groups (A, B, C, D) Class II, Groups (E, F & G) Class III, Division 1 (ia) Intrinsic Safe ATEX: EEx II 2 G EEx ia IIC T4, T5			-HC-XISC6		-HC-XISC6			-HC-XISC6	-HC-XISC6	-HC-XISC6

\* Coil temperature, "T" ratings, based on seal type \*\* For more information on E4SM see E Series catalog. † Upright solenoid cap (-U suffix) recommended.

# ELECTRICAL OPERATOR

## Recommended Solenoid Options - hazardous Location



### VALVE SERIES



	Power* (nominal)	NAMUR C5	NAMUR E5	NAMUR 316	C5/C7 C9	E4	E5	D	V	C-316	V-316
<b>North America CSA</b>											
	<b>Watts</b>										
Steel coil cover, 1/2" NPT Conduit entry, NEMA 7 & 9, UL & CSA. Steel. Electroless Nickel Plated, 24" Inch Leads	7.3		-XXL4			—	-XXL4	—		-XXL4†	
	1.8		-XXN4			—	-XXN4	—		-XXN4	
Stainless steel coil cover, 430 type for Hazardous Location. 1/2" NPT Conduit entry, with 24" wire leads. NEMA 7 & 9, UL & CSA.	7.3		-XXE4			—	-XXE4	—		-XXE4	
	1.8		-XXJ4			-XV9	-XXJ4	—		-XV9	
Stainless steel coil cover, 430 type, 1/2" Conduit entry, with 24" wire leads. (d) Flameproof, IP66, T4, ATEX	1.8		-XT4			-XT4	—	—		-XT4	
316L stainless steel coil housing with internal Junction Box.	1.8		-XDBT9**			-XDBT9**	—	—		-XDBT9**	
	3		—			—	—	-XDDT**			
<b>ATEX - IECEx - INMETRO</b>											
Steel coil cover, M20 x 1.5 Conduit entry, (d) Flameproof, IP66, T4, ATEX	7.3		-XNL4			—	-XNL4	—		-XNL4	
	1.8		-XNN4			—	-XNN4	—		-XNN4	
Stainless steel coil cover, 430 type, M20 x 1.5 Conduit entry, with 24" wire leads. (d) Flameproof, IP66, T4, ATEX	7.3		-XNE4			—	-XNE4	—		-XNE4	
	1.8		-XNJ4			—	-XNJ4	—		-XNJ4	
316L stainless steel coil housing with internal Junction Box.	1.8		-XDBS9**			-XDBS9**	—	—		-XDBS9**	
	3		—			—	—	-XDDS**		—	

\* For 0.85 and 0.50 watt, consult factory.

\*\* All the -XDBT\_ and XDD\_ type solenoids are "World Solenoids." Certified for North America, ATEX, IECEx and INMETRO

† For V Series brass add -TR50 option to -XXL4.

### VALVE SERIES

Miscellaneous Options		NAMUR C5	NAMUR E5	NAMUR C-316	C5/C7 C9	E4	E5	D	V	C-316	V-316
 <p><b>Manual Override</b> (manually pressurizes pilot or solenoid/pilot actuator).                      -CML: Unguarded locking type; push to operate and turn to lock.                      -G: Guarded manual override.                      -G5R: locking manual override with slotted pin for screwdriver operation.                      -M: Unguarded type; push &amp; hold to operate.                      -MAE: Unguarded, manual override.                      -ME: Unguarded type; push &amp; hold to operate                      -M5R: Unguarded locking manual override with a knurled knob, push to actuate and turn to lock.</p> <p>-ME shown</p>											
		-CML -G (std)	—	-ME	-CML -G	-G -G5R -M -M5R	-G G5R -M -M5R	-M -M5R	-G -G5R -M -M5R	-ME	
<p><b>Low Temperature Service</b></p> <p>-EP: Ethylene-Propylene Seals                      -44: Low Temperature Buna                      -T40 Fluorosilicone Elastomer</p>		— X —	X X —	— X —	— X —	X X —	X X —	— — X	X X X	— X —	X X X
<p><b>Dust Excluders</b></p> <p>Dust excluders for solenoid exhaust:</p> <p>-L14                      Dust Proof: (Suffix -L14, -E14)</p> <p>-D14                      Water Tight: (Suffix -D14)</p> <p>Hydraulic Adapter                      Threaded Solenoid Hydraulic Adapter: (Suffix -H = 1/4" NPT -H2 = 1/8" NPT)</p>				-L14 -D14				—	-E14 -D14	-L14 -D14	
				-H or -H2						-H or -H2	
<p><b>Natural Gas Service</b></p> <p>-NGS: The standard V-316 Series product is rated for air and gas service including natural gas. Versa recommends suffix detail -NGS for enhanced performance                      -NGST: For low temperature applications.</p>		-NGS -NGST	—	std -NGST	-NGS -NGST		std		-NGS -NGST	std -NGST	-NGS -NGST
<p><b>Stainless Steel Tag</b></p> <p>P- 2002-16-NV28A: Stainless Steel Tag part number</p> <p>Two configurations:                      1) Two lines of text, up to 20 characters.                      2) Two lines, one line is text, the second is sequential numbering. 20 characters per line.                      Consult factory for ordering details.</p> 				Yes			—			Yes	



# Modular Air Package

## VMAP Modular Air Package Based on the V-316 Series

### General Description

The Versa Modular Air Package is a compact air management system, based on V-316 Series components, that will provide a full range of pneumatic accessories and functions to meet the needs of most control systems in the actuator control industry. Major components are shutoff and check valves, filter/regulators, speed controls and directional control valves.

### Design Benefits

Versa's VMAP simplifies the design process by combining all the components of a common circuit into one integrated assembly. Whether a standard shutoff circuit or an intricate control system, VMAP has the features to meet the requirements of any control project. VMAP will reduce engineering, components, vendors, costs, weight and save time.

**TROUBLE FREE.** Designed with integral assembly flanges combined with all O-ring interface sealing and standard fasteners. Long leak free service life is accomplished. No custom or flat gaskets to leak or brackets to fail.

**TECHNOLOGY.** Utilizing the latest in computer aided design and finite element software flow is maximized yielding the highest flow in the smallest of packages.

**CUSTOM CIRCUITRY** is achieved through modular design by simply combining various components to create the desired circuit

**RELIABILITY.** The reliability of the Versa V-316 Series combined with industry approved materials yields a proven product. SIL (Safety Integral Levels) exceeding most application requirements.

**EFFICIENCY.** VMAP's modular design effectively groups common automation and controls components together in user approved groupings to combine features and reduce size and weight.

**PROVEN.** VMAP is based on Versa's field proven V-316 Series product having over 30 years of acceptance in providing bubble tight sealing though Versa's packed plunger technology.

**FLEXIBILITY.** Many standard and custom circuits are easily created using the VMAP modular concept.

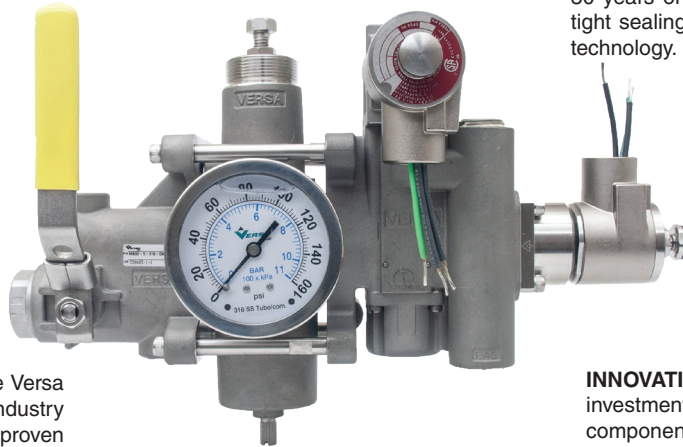

**INNOVATIVE.** Through the use of investment casting technology main components are integrated saving space while reducing potential leakage points.

### ENGINEERING BENEFITS

- Standard or custom circuits available utilizing VMAP's modular components.
- Convenience of one purchase order and one vendor.
- No need for developing Bill of Materials for fittings, tubing and bracketing.
- No need for designing complete layout of many different system components.
- No need for designing brackets for many individual components.

### FIELD BENEFITS

- Ease of repair: By removing a few screws the various modules can be disassembled and inspected, no tubing or fittings to remove
- Field configurability of function after installation: Add more valves as the requirements of the process change
- 10 year warranty

### INSTALLATION BENEFITS

- Reducing fittings, tubing and related labor costs
- Reduction in size and weight
- One component to mount

## Current Technology

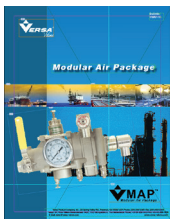

### NEW

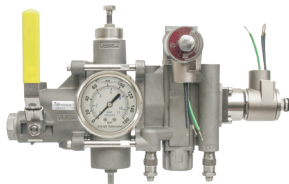

VMAP and Panel shown at scale

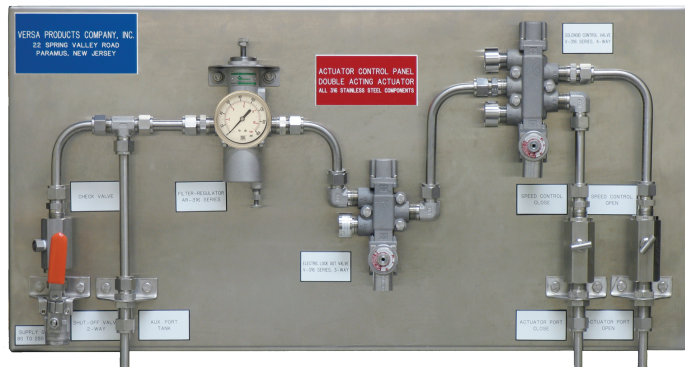

## AR-316 SERIES Stainless Steel Filter/Regulators



The Versa Type AR-316 series of stainless steel regulators and filter regulators are designed to stand up to the harshest environments while providing highly accurate pressure regulation. The over ported internal flow paths help the unit achieve high flow rates with minimal pressure drop.

The 316 stainless steel housing and filter assemblies, along with fluorocarbon diaphragm make

the ARFA stainless steel regulator ideal for sour gas and/or corrosive environments such as offshore operations.

The Versa AR-316 is NACE (NACE Standard MR0175) Compliant, meeting sulfide stress cracking material requirements. In the ARFB model, only the wetted parts are NACE compliant.

		ARFA*		ARNA		ANFA*
		Filter Regulator, Relieving Type**		Regulator Only, Relieving Type**		Filter Only
Size	Pressure	Nace 1***	Nace 2***	Nace 1***	Nace 2***	Nace 1***
1/4"	15-150	ARFA-3111-316-†	ARFB-3111-316-†	ARNA-3011-316-†	ARNB-3011-316-†	ANFA-3100-316-†
	10-100	ARFA-3112-316-†	ARFB-3112-316-†	ARNA-3012-316-†	ARNB-3012-316-†	—
	6-60	ARFA-3113-316-†	—	ARNA-3013-316-†	—	—
	3-30	ARFA-3114-316-†	—	ARNA-3014-316-†	—	—
3/8"	15-150	ARFA-4111-316-†	ARFB-4111-316-†	ARNA-4011-316-†	ARNB-4011-316-†	ANFA-4100-316-†
	10-100	ARFA-4112-316-†	ARFB-4112-316-†	ARNA-4012-316-†	ARNB-4012-316-†	—
	6-60	ARFA-4113-316-†	—	ARNA-4013-316-†	—	—
	3-30	ARFA-4114-316-†	—	ARNA-4014-316-†	—	—
1/2"	15-150	ARFA-5111-316-†	ARFB-5111-316-†	ARNA-5011-316-†	ARNB-5011-316-†	ANFA-5100-316-†
	10-100	ARFA-5112-316-†	ARFB-5112-316-†	ARNA-5012-316-†	ARNB-5012-316-†	—
	6-60	ARFA-5113-316-†	—	ARNA-5013-316-†	—	—
	3-30	ARFA-5114-316-†	—	ARNA-5014-316-†	—	—
1"	15-150	ARFA-7111-316-†	ARFB-7111-316-†	ARNA-7011-316-†	ARNB-7011-316-†	ANFA-7100-316-†
	10-100	ARFA-7112-316-†	ARFB-7112-316-†	ARNA-7012-316-†	ARNB-7012-316-†	—

† Suffix option(s) added here as required. See Suffix table on opposite page for options. All models supplied with (2) 1/4" NPT gauge ports. 2 plugs supplied loose. For factory installed plugs add suffix -RPB.

\* Filtration: Standard filter is 25 micron. For 5 micron filter change 6th character from 1 to 2. For 40 micron filter change from 1 to 3. For example change [ARFA-3111-316](#) to [ARFA-3211-316](#). Coalescing filter available on 1/4" & 1/2" "Filter Only" units (ANFA's). Change 1 to 4. For example [ANFA-3400-316](#).

\* Drain: Standard filter supplied with manual drain. For AutoDrain change 3rd character from F to D. Example change [ARFA-3111-316](#) to [ARDA-3111-316](#). AutoDrain supplied with 1/4" npt drain connection. 150 psi maximum. For increased volume filter bowl on 1/4"-1/2" ARFA & ANFA change part number to ARLA or ANLA.

\*\* Regulator Type: Standard regulator is relieving type. For non-relieving type change 7th character from 1 to 2. For example change [ARFA-3111-316](#) to [ARFA-3121-316](#). Note: For extended filter bowl on 1/4", 3/8" or 1/2" ARFA & ANFA change part number to ARLA or ANLA.

\*\*\* NACE 1 ARFA/ARNA/ANFA items are fully NACE compliant. NACE 2 ARFB/ARNB units, only wetted parts are NACE compliant, adjusting spring is 316 stainless steel.

# Air Prep

## AR II-316 Series



The Versa Type AR II-316 is an economical, general-purpose, 1/4" NPT ported, stainless steel filter regulator with integral mounting hubs on the bonnet.

This quality instrument is designed using the most current flow optimization software that yields a regulator with the highest flow for unit size.

The 316 stainless steel body, housing and

filter assemblies and fluorocarbon diaphragm make the AR II compatible with sour gas and suitable for offshore environments.

The Flow path wetted parts are NACE compliant (NACE Standard MR0175), meeting sulfide stress cracking material requirements. An optional Inconel spring makes the AR II fully NACE compliant.

		ARFC*		ARNA		ANFA*
		Filter Regulator, Relieving Type**		Regulator Only, Relieving Type**		Filter Only
Size	Pressure	Nace 1***		Nace 1***	Nace 2***	Nace 1***
1/4"	15-150	ARFC-3111-316-†	ARFD-3111-316-†	ARND-3011-316-†	ARND-3011-316-†	ANFA-3100-316-†
	10-100	ARFC-3112-316-†	ARFD-3112-316-†	ARND3012-316-†	ARND-3012-316-†	—
	6-60	ARFC-3113-316-†	—	ARND-3013-316-†	—	—
	3-30	ARFC-3114-316-†	—	ARND-3014-316-†	—	—

## ARH-316 High Pressure Regulator



Versa's single stage, high pressure regulator is designed to accept up to 6000 psi input and reduce it to a working range of 10 to 500 psi. Making the ARH ideal for a first cut Natural Gas high pressure regulator.

The Type ARH-316 Series of stainless steel regulators are designed to stand up to the harshest environments while providing highly accurate pressure regulation. Proven 316L stainless steel housing assembly and

stainless steel diaphragm make the ARH-316 ideal for challenging applications such as pipelines, offshore platforms and sour gas media.

The combined characteristics of high flow and minimal air consumption mean efficient economical operation.

The all 316L stainless steel construction and is compliant with NACE Standard MR0175, meeting sulfide stress cracking material requirements.

		Regulator
		Non Relieving
Size	Pressure	Part Number*
1/4"	10-75	ARHB-3321-316-†
	50-150	ARHB-3322-316-†
	100-250	ARHB-3323-316-†
	200-500	ARHB-3324-316-†

\* For NACE Compliance change ARHB to ARHA  
 † Suffix option(s) added here as required. See Suffix Options below.

# Air Prep

## AFH-316 High Pressure Filter



AFHA-3050  
Shown  
VMAP Capable

Versa's AFH-316 Series high pressure filter is designed to accept up to 6000 psi input and is available in three configurations, 1/4" NPT inline mounting, 1/4" NPT inline mounting with additional outlet port in the cap and manifold mount.

Proven 316L stainless steel housing assembly with two types of filter elements, polyethylene or 316 stainless steel, make the AFH-316 ideal for challenging applications such as pipelines, offshore platforms and sour gas media.

Replacement Element	
Filter Material	Part Number
Polyethylene	AFH-090-105-10-RK
Polyethylene	AFH-090-105-25-RK
316 Stainless Steel	AFH-090-105-03-316-RK
316 Stainless Steel	AFH-090-105-10-316-RK
316 Stainless Steel	AFH-090-105-25-316-RK

Suffix Options	
Suffix detail	Description
-2B	1/4G thread
-EP	Low Temperature service, Ethylene Propylene
-44	Low Temperature service, low temp Buna
-VA	Filter for VMAP installation

## Accessories

### Dust Excluders



Versa Dust Excluders are available in aluminum and 316 Stainless Steel. They can be threaded into the exhaust port of a directional control valve and offer effective protection against dirt, dust, moisture and insects entering the valve, through the exhaust port, without obstructing the flow.

THREAD SIZE	PRODUCT NUMBER	
	ALUMINUM	STAINLESS STEEL†
1/8" NPT	DE-2	
1/4" NPT	DE-3	DE-3-316
3/8" NPT	DE-4	DE-4-316
1/2" NPT	DE-5	DE-5-316
3/4" NPT	DE-6	DE-6-316
1" NPT	DE-7	DE-7-316

### Vent Screens



Versa Vent Screens are available in 316 Stainless Steel. Threaded into the exhaust port of a directional control valve they offer effective protection against dirt, dust and insects entering the valve, with minimal effect on flow.

VENT SCREEN	
THREAD SIZE	PRODUCT NUMBER MATERIAL 316
1/8" NPT	MFS-2-316
1/4" NPT	MFS-3-316
3/8" NPT	MFS-4-316
1/2" NPT	MFS-5-316
3/4" NPT	MFS-6-316
1" NPT	MFS-7-316

# Accessories

## Bleed Controls



Versa Bleed Control Valves provide economical, effective speed control for pneumatic cylinders.

Installation in the exhaust port of directional control valves provides cylinder speed control by metering the flow from the exhaust port.

Accurate cylinder speed is achieved by the adjustment of a threaded needle valve. The provided locking nut assures the flow setting is maintained.

They are available from 1/8" to 1" NPT in brass and stainless steel.

CONNECTIONS	PRODUCT NUMBER	
	BRASS	STAINLESS STEEL
PORT SIZE	BC-2	
1/8" NPT	BC-2	
1/4" NPT	BC-3	BC-3-316
3/8" NPT	BC-4	BC-4-316
1/2" NPT	BC-5	BC-5-316
3/4" NPT	BC-6	BC-6-316
1" NPT	BC-7	BC-7-316

## Quick Exhaust Valves



A Quick Exhaust Valve is a 3/2 valve with an extra-large exhaust orifice; a three-ported valve with the inlet port, cylinder port and, one pipe size larger exhaust port, designed to be fitted directly to the cylinder port.

The main purpose of a Quick Exhaust Valve is to accelerate the movement of the cylinder rod or valve actuator, by rapidly venting, to atmosphere, the air contained in the cylinder or actuator.

When the inlet port is pressurized, the exhaust port is closed by the "Flapper" ("Shuttle" on QE-6-316) and the inlet port is connected to the cylinder port. When the pressure falls at the inlet, the cylinder port is automatically opened to the exhaust and, the cylinder is rapidly depressurized.

Size			PRODUCT NUMBER
Inlet	Cyl	Exhaust	
1/4" NPT	1/4" NPT	3/8" NPT	QE-3
1/4" NPT	1/4" NPT	3/8" NPT	QE-3-316
1/2" NPT	1/2" NPT	3/4" NPT	QE-5-316
3/4" NPT	3/4" NPT	1" NPT	QE-6-316
1" NPT	1 1/2" NPT	1 1/2" NPT	QE-7-316
1 1/2" NPT	1 1/2" NPT	1 1/2" NPT	QE-9-316

## Shuttle Valves



Versa Shuttle Valves are constructed of Brass or 316 Stainless Steel\*, with resilient seals providing tight shut off. Shuttle valves are 3/2 valves, primarily used to charge and discharge a pressure line or chamber from two - or more - sources.

Shuttle Valves have a free moving shuttle that blocks one of two inlet ports while the other inlet port is connected to the (common) outlet port. When a pressure signal enters the port blocked by the shuttle, it will cause the shuttle to shift over to close the opposite inlet port. The shuttle will stay there while the line or chamber connected to the outlet port is charged and/or discharged and will only shift when pressure is applied to the inlet port it is blocking at that time.

\*conforms to NACE standard MR-01-75

Port Size	Product Number	
	Brass	Stainless Steel
1/4" NPT	SV-3	SV-3-316†
3/8" NPT	SV-4	
1/2" NPT	SV-5	SV-5-316†
3/4" NPT	SV-6	



# Accessories

## Flow Control Valve

Versa Products Company's Flow Control Valve (FCV) is a *316 stainless steel, NACE compliant\** device combining a check and needle valve to control the speed of pneumatic actuators and cylinders.

The FCV allows unrestricted *full flow* in one direction and adjustable flow in the reverse.

The key to Versa's full flow is the internal design and the Versa "shuttle." This combination provides a larger surface area and yields much higher flows than controls utilizing ball checks. When the flow is reversed, placing pressure on the "shuttle" it rapidly opens to a high flow orifice that instantly empties the volume in the line.

Flow adjustment is controlled by Versa's proven needle design from our "Bleed Control" family of products.



FCV			
THREAD SIZE	PRODUCT NUMBER	Cv	
		Controlled Direction	Uncontrolled Direction
¼"	FCV-3-316	0** to 2.0	2.0
½"	FCV-5-316	0** to 5.0	5.0
1"	FCV-7-316	0** to 9.5	13.6

## Check Valve

Versa Products Company's Check Valve (CV) is a *316 stainless steel, NACE compliant\** device designed to prevent reverse flow in a pneumatic circuit.

The CV allows unrestricted *full flow* in one direction and blocked Bubble Tight flow in the reverse.

The Versa Check Valve uses a pilot spring assist "shuttle" to block the reverse flow. As the line pressure drops the "shuttle" is moved by the spring and air from the downstream side, into its seat, blocking reverse flow. The maintained air pressure and the spring assure a positive seal.



CV		
PRODUCT NUMBER	Cv	Weights
		lbs (kg)
CV-3-316	2.0	0.54 (0.24)
CV-5-316	5.0	0.86 (0.4)
CV-7-316	13.6	3.1 (1.4)

## Needle Valve

Versa Products Company's Needle Valve (NV) is a *316 stainless steel, NACE compliant\** device designed to meter flow in a pneumatic circuit.

The flow can be gradually adjusted from zero (closed) to maximum (full open, 10 turns). Constant flow can be secured at the required setting by tightening the lock nut. Flow adjustment is controlled by Versa's proven needle design from our "Bleed Control" family of products.



NV	
PRODUCT NUMBER	Cv
NV-3-316	0 to 2.0
NV-5-316	0 to 5.0

## WARNINGS REGARDING THE DESIGN APPLICATION, INSTALLATION AND SERVICE OF VERSA PRODUCTS

The warnings below must be read and reviewed before designing a system utilizing, installing, servicing, or removing a Versa product. Improper use, installation or servicing of a Versa product could create a hazard to personnel and property.

### DESIGN APPLICATION WARNINGS

Versa products are intended for use where compressed air or industrial hydraulic fluids are present. For use with media other than specified or for non-industrial applications or other applications not within published specifications, consult Versa.

Versa products are not inherently dangerous. They are only a component of a larger system. The system in which a Versa product is used must include adequate safeguards to prevent injury or damage in the event of system or product failure, whether this failure be of switches, regulators, cylinders, valves or any other system component. System designers must provide adequate warnings for each system in which a Versa product is utilized. These warnings, including those set forth herein, should be provided by the designer to those who will come in contact with the system.

Where questions exist regarding the applicability of a Versa product to a given use, inquiries should be addressed directly to the manufacturer. Confirmation should be obtained directly from the manufacturer regarding any questioned application prior to proceeding.

### INSTALLATION, OPERATION AND SERVICE WARNINGS

Do not install or service any Versa product on a system or machine without first depressurizing the system and turning off any air, fluid, or electricity to the system or machine. All applicable

electrical, mechanical, and safety codes, as well as applicable governmental regulations and laws must be complied with when installing or servicing a Versa product.

Versa products should only be installed or serviced by qualified, knowledgeable personnel who understand how these specific products are to be installed and operated. The individual must be familiar with the particular specifications, including specifications for temperature, pressure, lubrication, environment and filtration for the Versa product which is being installed or serviced. Specifications may be obtained upon request directly from Versa. If damages should occur to a Versa product, do not operate the system containing the Versa product. Consult Versa for technical information.

### LIMITED WARRANTY DISCLAIMER AND LIMITATION OF REMEDIES

Products sold by Versa are warranted to be free from defective material and workmanship for a period of ten years from the date of manufacture, provided said items are used in accordance with Versa specifications. Versa's liability pursuant to that warranty is limited to the replacement of the Versa product proved to be defective provided the allegedly defective product is returned to Versa or its authorized distributor.

Versa provides no other warranties, expressed or implied, except as stated above. There are no implied warranties of merchantability or fitness for a particular purpose. Versa's liability for breach of warranty as herein stated is the only and exclusive remedy and in no event shall Versa be responsible or liable for incidental or consequential damages.

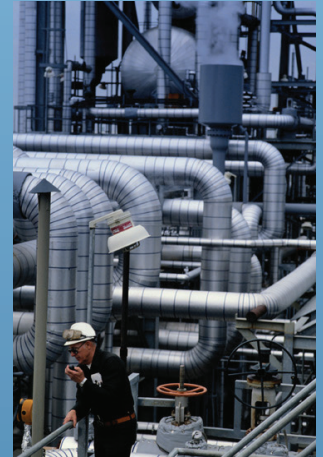

[www.versa-valves.com](http://www.versa-valves.com)

e-mail: [sales@versa-valves.com](mailto:sales@versa-valves.com)